

# **BIDDING DOCUMENT**

**FOR**

## **THE PROCUREMENT OF**

**LT line Reinforcement works (Wooden Poles Replacement) at Various places of Pokhara Municipality, Annapurna, Machhapuchhre, Madi Gaupalika.**

### **Sealed Quotation**

Issued by:

NEA, Pokhara Distribution Center

Malepatan Kaski

Sealed Quotation Number

NEA-PDC-2081/082-09(SQ)

Issued On

22-01-2025

## **Abbreviations**

BD	.....	Bidding Document
BDF	.....	Bidding Forms
BDS	.....	Bid Data Sheet
BOQ	.....	Bill of Quantities
COF	.....	Contract Forms
DP	.....	Development Partners
ELI	.....	Eligibility
GCC	.....	General Conditions of Contract
GoN	.....	Government of Nepal
ICC	.....	International Chamber of Commerce
IFQ	.....	Invitation for Quotations
ITB	.....	Instructions to Bidders
NCB	.....	National Competitive Bidding
PAN	.....	Permanent Account Number
PPA	.....	Public Procurement Act
PPMO	.....	Public Procurement Monitoring Office
PPR	.....	Public Procurement Regulations
SBD	.....	Standard Bidding Document
SCC	.....	Special Conditions of Contract
SQ	.....	Sealed Quotation
TS	.....	Technical Specifications
VAT	.....	Value Added Tax
WRQ	.....	Works Requirement

# Table of Contents

Section I.	Instruction to Bidders (ITB)	
Section II.	Bid Data Sheet (BDS)	
Section III.	Eligibility Criteria	
Section IV	Bidding Forms	
Section V	Works Requirements	
Section VI.	Bill of Quantities	
Section VII.	General Conditions of Contract	(GCC)
Section VIII.	Special Conditions of Contract	(SCC)
Section IX	Contract Forms	

# Invitation for Sealed Quotation

Name of the Office: NEA, Pokhara Distribution Center

Address of the Office:

Malepatan Kaski

Sealed Quotation No: NEA-PDC-2081/082-09(SQ)

Date of Publication : 22-01-2025

1. The NEA, Pokhara Distribution Center invites sealed quotations from registered contractors for the construction of LT line Reinforcement works (Wooden Poles Repla...
2. The Estimated amount for the works is (in NRs.): 604,117.52 (Exclusive of VAT and Contingencies)
3. Eligible Bidders may obtain further information and inspect the Sealed quotation Forms at the office of NEA, Pokhara Distribution Center at Malepatan Kaski or by reaching out to them at Telephone 061520472 or by dropping a mail at pokhara@nea.org.np [or may visit PPMO website www.bolpatra.gov.np.]
4. Sealed Quotation Forms may be purchased by eligible Bidders on the submission of a written application and upon payment of a non-refundable fee of 1000.0 NRs.

Or

Bidder who chooses to submit their bid electronically shall deposit the cost of bidding document in the account specified below:

Name of the Bank: Nabil Bank Ltd.

Name of the Office: NEA, Pokhara Distribution Center

Office Code no:

Office Account no: 1201013042301

Rajaswa (revenue) Shirshak no:

5. Sealed bids must be submitted to the above office by hand or through e-GP system i.e www.bopatра.gov.np/egp on or before 06-02-2025 12:00 hours . Bids received after this deadline will be rejected.
6. Sealed Quotations shall be opened in the presence of Bidders' representatives who choose to attend at 06-02-2025 14:05 hours at the office of NEA, Pokhara Distribution Center, Bids must be valid for a period of 45 days after bid opening and must be accompanied by a bid security amounting to a minimum of NRs.17500 which shall be valid for 30 days beyond the validity period of the bid i.e 75 days.
7. If the last date of purchasing and /or submission falls on a government holiday, then the next working day shall be considered as the last date. In such case the validity period of the bid security shall remain the same as specified for the original last date of bid submission.

[Note : As mentioned in clause 49ka of PPR 2064 clause 49ka ,add more relevant information as per required]

**Section - II**  
**Instruction to Bidders**

## Section I. Instruction to Bidders(ITB)

<p><b>1. Scope of Works</b></p>	<p>1.1 The Employer stated in the BDS for the construction of works as detailed in attached specifications, drawings and the bill of quantities provided herein. The name of <i>Employer, name of project and contract identification number of Contracts</i> are <b>provided in the BDS.</b></p>
<p><b>2. Eligible Bidder</b></p>	<p>2.1 This Invitation for Bids is open to all registered contractors with eligibility criteria specified in section III Eligibility Criteria. A bidder declared blacklisted and ineligible by the GoN, Public Procurement Monitoring Office (PPMO) and/or the DP in case of DP funded project, shall be ineligible to bid for a contract during the period of time determined by the GoN, PPMO and/or the DP.</p> <p>2.2 In case of a natural person or firm/institution/company which is already declared blacklisted and ineligible by the GoN, any other new or existing firm/institution/company owned partially or fully by such Natural person or Owner or Board of director of blacklisted firm/institution/company; shall not be eligible bidder.</p> <p>2.3 Firms shall be excluded if the corruption case is being filed to Court against the Natural Person or Board of Director of the firm/institution /company or any partner of JV, such Natural Person or Board of Director of the firm/institution /company or any partner of JV shall not be eligible to participate in procurement process till the concerned Court has not issued the decision of clearance against the Corruption Charges</p>
<p><b>3. One Bid per Bidder</b></p>	<p>3.1 Each Bidder shall submit only one quotation. A Bidder who submits more than one quotation shall cause all the quotations with the Bidder's participation to be disqualified.</p>
<p><b>4. Cost of Bidding</b></p>	<p>4.1 The Bidder shall bear all costs associated with the preparation and submission of his bid and the Employer shall in no case be liable for those costs.</p>
<p><b>5. Site Visit</b></p>	<p>5.1 The Bidder at his own cost, responsibility and risk may visit the site of the works and acquire all necessary information for preparing the bid and entering into a contract for construction of the works.</p>
<p><b>6. Content of Quotation Form</b></p>	<p>6.1 The Quotation Form comprise the documents listed below:  Section I: Instructions to Bidders  Section II: Bid Data Sheet  Section III : Eligibility Criteria  Section IV: Bidding Forms  Section V: Works Requirements  Section VI: Bill of Quantities  Section VII: General Conditions of Contract (GCC)  Section VIII: Special Conditions of Contract (SCC)  Section IX: Contract Forms</p>

<b>7. Clarification</b>	7.1 A prospective Bidder may obtain clarification on the Quotation Form from the Employer on or before 5 days prior to the deadline for submission of quotation.
<b>8. Language of Bid</b>	8.1. All documents relating to the bid shall be in English /Nepali.
<b>9. Documents Comprising Bid</b>	<p>The bid by the Bidder shall comprise the following:</p> <ul style="list-style-type: none"> <li>• Letter of Bid</li> <li>• Eligibility Information/Document</li> <li>• Bid Security and</li> <li>• Priced Bill of Quantities</li> </ul>
<b>10. Bid Prices</b>	<p>10.1 The contract shall be for the whole works described in scope of works based on the priced Bill of Quantities submitted by the Bidder. The Bidder shall fill in rates and prices for all items of the works in Nepali Rupees. Items for which no rate or price is entered shall be deemed covered by the other rates and prices in the Bill of Quantities and shall not be paid separately by the Employer.</p> <p>All duties, taxes and other levies payable by the contractor under the contract shall be included in the rates, prices and total Bid Price submitted by the Bidder.</p>
<b>11. Bid Validity</b>	11.1 Bids shall remain valid for the period <b>specified in the BDS</b> after the bid submission deadline date prescribed by the Employer. A bid valid for a shorter period shall be rejected by the Employer as nonresponsive.
<b>12. Bid Security</b>	<p>12.1 The Bidder shall furnish as part of its bid, in original form, a bid security <b>as specified in the BDS</b>. In case of e-submission of bid, the Bidder shall upload scanned copy of Bid security letter at the time of electronic submission of the bid. The Bidder accepts that the scanned copy of the Bid security shall, for all purposes, be equal to the original. The details of original Bid Security and the scanned copy submitted with e-bid should be the same otherwise the bid shall be non-responsive.</p> <p>12.2 The bid security shall be, at the Bidder's option, in any of the following forms:</p> <ul style="list-style-type: none"> <li>(a) an unconditional bank guarantee from Commercial Bank or Financial Institution eligible to issue Bank Guarantee as per prevailing Law or;</li> <li>(b) a cash deposit voucher in the Employer's Account as specified in BDS.</li> </ul> <p>In the case of a bank guarantee, the bid security shall be submitted either using the Bid Security Form included in Section III (Bidding Forms) or in another Form acceptable to the employer. The form must include the complete name of the Bidder. The bid security shall be valid for minimum thirty (30) days beyond the original validity period of the bid</p> <p>12.3 Any bid not accompanied by an enforceable and substantially compliant bid security shall be rejected by the Employer as nonresponsive. In case of e-Submission, if the scanned copy of an acceptable Bid Security letter is not uploaded with the electronic Bid then Bid shall be rejected.</p> <p>12.4 The bid security shall be forfeited if:</p> <ul style="list-style-type: none"> <li>(a) a Bidder requests for withdrawal during the period of bid validity specified by the Bidder on the Letter of Bid, after bid submission deadline.</li> <li>(b) a Bidder changes the prices or substance of the bid while providing information;</li> <li>(c) a Bidder involves in fraud and corruption pursuant to clause 27;</li> <li>(d) the successful Bidder fails to:</li> </ul>

	<p>(i) furnish a performance security in accordance with clause 25 and 26;</p> <p>(ii) sign the Contract in accordance within the period stipulated in Letter of Acceptance;</p> <p>or</p> <p>(iii) accept the correction of arithmetical errors pursuant to clause 21.1</p>
<b>13. Format and Signing of Bids</b>	13.1 The bid shall be typed or written in indelible ink and shall be signed by an authorized person. Any entries or amendments including alternations, additions or corrections made shall be initialed by the same authorized person.
<b>14. Sealing and Marking of Bids</b>	<p>14.1 Bidders may submit their bids by hand copy or by electronically. When so <b>specified in the BDS</b>, bidders shall have the option of submitting their bids electronically. Procedures for submission, sealing and marking are as follows:</p> <p>(a) Bidders submitting bids by hand copy: The Bidder shall submit his bid in sealed envelopes. The envelope shall be addressed to the Employer specified in the Invitation for Quotation and shall bear the name and identification number of the quotation.</p> <p>(b) Bidders submitting Bids electronically shall follow the electronic bid submission procedure <b>specified in the BDS</b></p>
<b>15. Deadline for Submission of Bids</b>	15.1 Bids shall be delivered to the Employer at the address no later than the time and date <b>specified in BDS</b> .
<b>16. Late Bids</b>	16.1 Any bid received by the Employer after the deadline shall not be accepted and shall be returned unopened to the Bidder upon request.
<b>17. Modification And Withdrawal of Bids</b>	17.1 Bids once submitted shall not be withdrawn or modified.
<b>18. Bid Opening</b>	18.1 The Employer shall open the bids in the presence of the Bidders' representatives who choose to attend at the time and in the place <b>as specified in the BDS</b> . The Employer shall prepare and provide minutes of the bid opening including the information disclosed to those present.
<b>19. Process to be Confidential</b>	19.1 Information relating to the examination, evaluation and comparison of bids and recommendations for the award of a contract shall not be disclosed to Bidders or any other persons not officially concerned with such process until the award to the successful Bidder has been announced. Any efforts by the Bidder to influence the Employer in the bid evaluation, bid comparison or contract award decisions may result in rejection of Bidder's bid.
<b>20. Examination of Bids</b>	20.1. Prior to the detailed evaluation of Bids, the Employer shall determine whether each bid (a) meets the eligibility criteria defined in Clause 2; (b) has been properly signed; (c) is accompanied by the required securities; and (d) is substantially responsive to the requirements of the Bidding documents.
<b>21. Evaluation and Comparison of Bids</b>	21.1 In evaluating the Bids, the Employer shall determine for each bid the evaluated Bid Price by adjusting any corrections for errors. Bids shall be checked by the Employer for any arithmetic errors. Errors shall be corrected by the Employer as follows:



	<p>(a) only for unit price Contracts, if there is a discrepancy between the unit price and the total price that is obtained by multiplying the unit price and quantity, the unit price shall prevail and the total price shall be corrected, unless in the opinion of the Employer there is an obvious misplacement of the decimal point in the unit price, in which case the total price as quoted shall govern and the unit price shall be corrected;</p> <p>(b) if there is an error in a total corresponding to the addition or subtraction of subtotals, the subtotals shall prevail and the total shall be corrected; and</p> <p>(c) If there is a discrepancy between the bid price in the Summary of Bill of Quantities and the bid amount in item (c) of the Letter of Bid, the bid price in the Summary of Bill of Quantities will prevail and the bid amount in item (c) of the Letter of Bid will be corrected.</p> <p>(d) if there is a discrepancy between words and figures, the amount in words shall prevail, unless the amount expressed in words is related to an arithmetic error, in which case the amount in figures shall prevail subject to (a) ,(b) and (c) above.</p> <p>21.2 In case of e-submission of bid, upon notification from the employer, the bidder shall also submit the original of documents comprising the bid as per ITB 9 for verification of submitted documents for acceptance of the e-submitted bid. If a Bidder does not provide original of document of its bid by the date and time set in the Employer’s request for clarification, its bid may be rejected.</p> <p>21.3 If the Bidder that submitted the lowest evaluated bid does not accept the correction of errors, its bid shall be disqualified and its bid security shall be forfeited.</p> <p>21.4 If the corruption case is being filed to Court against the Natural Person or Board of Director of the firm/institution /company or any partner of JV, such Natural Person or Board of Director of the firm/institution /company or any partner of JV such bidder’s bid shall be excluded during the evaluation.</p>
<p><b>22. Award of Contract</b></p>	<p>22.1 The Employer shall decide the award of the contract to the Bidder whose bid is within the approved estimate and who has offered the lowest evaluated Bid Price within bid validity period provided that such Bidder has been determined to be eligible in accordance with the provisions of Clauses 2.</p> <p>22.2 if the bid for an Unit Rate Contract, which results in the lowest Evaluated Bid Price is seriously unbalanced or front loaded <b>or extremely low</b> in the opinion of the Employer, the Employer may require the Bidder to produce detailed price analysis for any or all items of the Bill of Quantities, to demonstrate the internal consistency of those prices with the construction methods and schedule proposed. After evaluation of the price analysis, taking into consideration the schedule of estimated Contract payments, the Employer may require that the amount of the performance security be increased at the expense of the Bidder as <b>mentioned in BDS</b> to protect the Employer against financial loss in the event of default of the successful Bidder under the Contract <b>or may consider the bid as non-responsive</b>.</p>
<p><b>23. Employer's Right to Accept any Bid and to Reject any or all Bids</b></p>	<p>23.1 The Employer reserves the right to accept or reject any bid or to cancel the bidding process and reject all bids, at any time prior to the award of the contract, without assigning any reasons whatsoever and without thereby incurring any liability to the affected Bidder or Bidders.</p>
<p><b>24. Notification of Award and</b></p>	<p>24.1 The Bidder whose bid is accepted and all other participating bidders shall be notified of the award by the Employer.</p>

<p><b>Signing of Agreement</b></p>	<p>24.2 The notification (hereafter called the “Letter of Acceptance”) to the successful Bidder shall state the sum that the Employer shall pay the Bidder in consideration of the execution, completion, and maintenance of the works as described by the contract. Within 7 days of receipt of the Letter of Acceptance, the successful Bidder shall deliver the Performance Security pursuant Clause 25 and sign the Agreement.</p> <p>24.3 Inability of the Bidder to make an Agreement within the above stated period shall result in cancellation of the Contract Award and forfeiture of the Bidder’s Bid Security, upon which the Contract shall then be awarded to the next successive successful Bidder.</p>
<p><b>25. Performance Security</b></p>	<p>25.1. Within seven (7) days of the receipt of Letter of Acceptance from the Employer, the successful Bidder shall furnish the performance security as under mentioned from Commercial Bank or Financial Institution eligible to issue Bank Guarantee as per prevailing Law in Nepal in accordance with the conditions of Contract using Sample Form for the Performance Security included in Section IX (Contract Forms), or another form acceptable to the Employer.</p> <p>i) If bid price of the bidder selected for acceptance is up to 15 (fifteen) percent below the approved cost estimate, the performance security amount shall be 5 (five) percent of the bid price.</p> <p>ii) For the bid price of the bidder selected for acceptance is more than 15 (fifteen) percent below of the cost estimate, the performance security amount shall be determined as follows:</p> <p><b>Performance Security Amount =</b>  <b>[(0.85 x Cost Estimate – Bid Price) x 0.5] + 5% of Bid Price.</b></p> <p>The Bid Price and Cost Estimate shall be inclusive of Value Added Tax.</p>
<p><b>26. Additional Securities</b></p>	<p>26.1 The Bidder may be required to provide additional Performance Security if the Employer determines that the rate quoted by the Bidder in the Bill of Quantities, front loaded or unbalanced. In such case, the Employer shall instruct the Bidder to provide additional 8% security for signing of the Contract Agreement. Bidder’s failure to do provide additional security shall result in forfeiture of the Bid Security and award of the Contract to the next lowest evaluated Bidder.</p>
<p><b>27. Corrupt or Fraudulent Practices</b></p>	<p>27.1 The Employer shall reject a bid for award if it determines that the Bidder recommended for award of contract has engaged in corrupt or fraudulent practices in competing for the contract in question.</p>
<p><b>28. Conduct of Bidders</b></p>	<p>28.1 The Bidder shall be responsible to fulfill his obligations as per the requirement of the Contract Agreement, Bidding documents, GoN’s Procurement Act and Regulations.</p> <p>28.2 The Bidder shall not carry out or cause to carry out the following acts with an intention to influence the implementation of the procurement process or the procurement agreement :</p> <ol style="list-style-type: none"> <li>a) give or propose improper inducement directly or indirectly,</li> <li>b) distortion or misrepresentation of facts</li> <li>c) engaging or being involved in corrupt or fraudulent practice</li> <li>d) Interference in participation of other prospective bidders.</li> <li>e) coercion or threatening directly or indirectly to cause harm to the person or the property of any person to be involved in the procurement proceedings,</li> </ol>

	<ul style="list-style-type: none"> <li>f) collusive practice among bidders before or after submission of bids for distribution of works among bidders or fixing artificial/uncompetitive bid price with an intention to deprive the Employer the benefit of open competitive bid price..</li> <li>g) contacting the Employer with an intention to influence the Employer with regards to the bid or interference of any kind in examination and evaluation of the bids during the period after opening of bids up to the notification of award of contract</li> </ul>
<p><b>29.Blacklisting Bidder</b></p>	<p>29.1 Without prejudice to any other right of the Employer under this Contract, GoN, Public Procurement Monitoring Office may blacklist a bidder for his conduct up to three years on the following grounds and seriousness of the act committed by the bidder:</p> <ul style="list-style-type: none"> <li>a) if it is proved that the bidder committed acts pursuant to the Sub-Clause 28.2,</li> <li>b) if it is proved later that the bidder/contractor had committed substantial defect in implementation of the contract or had not substantially fulfilled his obligations under the contract or the completed work is not of the specified quality as per the contract ,</li> <li>c) if convicted by a court of law in a criminal offence which disqualifies the bidder from participating in the contract.</li> <li>d) if it is proved that the contract agreement signed by the bidder was based on false or misrepresentation of bidder’s qualification information,</li> </ul> <p>29.2 A firm declared blacklisted and ineligible by the GON shall be ineligible to bid for a contract during the period of time determined by the PPMO.</p>
<p><b>30. Provision of PPA and PPR</b></p>	<p>If any provision of this document is inconsistent with Public Procurement Act (PPA), 2063 or Public Procurement Regulations (PPR), 2064, the provision of this documents shall be void to the extent of such inconsistency and the provision of PPA and PPR shall prevail.</p>

Section - II  
Bid Data Sheet

## Bid Data Sheet

ITB 1	The scope of work is : WORKS SEALED QUOTATION
ITB 1	The number of the Invitation for Bids is : NEA-PDC-2081/082-09(SQ)
ITB 1	The Employer is : NEA, Pokhara Distribution Center
ITB 11	The bid validity period shall be: 45 days.
ITB 12.1	The Bidder shall furnish a bid security, from 'A' class commercial bank with a minimum of 17500, which shall be valid for 30 days beyond the validity period of the bid.
ITB 12.2	<p>Cash Deposit Account for Bid Security :</p> <p>Bank Name: Nabil Bank Ltd.</p> <p>Bank Address: Pokhara Municipality</p> <p>Account Name: NEA Pokhara Distribution Center</p> <p>Account Number: 1201013042301</p>
ITB 14.1	<p>Bidders shall have the option of submitting their bids electronically.</p> <p>Electronic submission procedure shall be :</p> <ol style="list-style-type: none"> <li>i. The bidder is required to register in the e-GP system <a href="https://www.bolpatra.gov.np/egp">https://www.bolpatra.gov.np/egp</a> following the procedure specified in e-GP guideline.</li> <li>ii. Interested bidders may either purchase the bidding document from the employer's office as specified in the Invitation for Bid (IFB) or bidders may download the IFB and bidding document from e-GP system.</li> <li>iii. The registered bidders need to maintain their profile data required during preparation of bids.</li> <li>iv. In order to submit their bids electronically the cost of the bidding document shall be deposited in the account specified in IFB. In addition, electronic scanned copy (.pdf format) of the bank deposit voucher/cash receipt should also be submitted along with the bid.</li> <li>v. The bidder can prepare their bids using data and documents maintained in bidder's profile and forms/format provided in bidding document by Employer. The bidder may submit bids as a single entity.</li> <li>vi. Bidders should update their profile data and documents required during preparation and submission of their bids. The required forms and documents shall be part of technical bids. <ol style="list-style-type: none"> <li>1. Letter of Bid (Mandatory)</li> <li>2. Bid Security/Bank Guarantee (Mandatory)</li> <li>3. Company registration (Mandatory)</li> <li>4. VAT registration (Mandatory)</li> <li>5. Tax clearances certificate or evidence of tax return submission (Mandatory)</li> <li>6. Power of Attorney of Bid signatory (Mandatory)</li> <li>7. Completed BoQ (Mandatory)</li> <li>8. Bank Voucher for cost of bid document (Mandatory)</li> <li>9. Additional documents specified in Bidding Document (If required)</li> </ol> <p>Note : The documents specified as "Mandatory" should be included in e-submission.</p> </li> <li>vii. After providing all the details and documents, bid response documents will be generated from the system. Bidders are advised to download and verify the response documents prior to bid submission.</li> <li>viii. For verifying the authentic user, the system will send one time password in the registered email address of the bidder. System will validate the OTP and allow bidder to submit their bid.</li> <li>ix. Once bid is submitted, bidders won't able to modify/withdrawal their bid.</li> <li>x. The Bidder / Bid shall meet the following requirements and conditions for e-submission of bids : <p>The e-submitted bids must be readable through PDF reader.</p> <p>The facility for submission of bid electronically through e-submission is to promote transparency, non-discrimination, equality of access, and open competition in the bidding process. The Bidders are fully responsible to use the e-submission facility properly in e-GP system as per specified procedures and in no case the Employer shall be held liable for Bidder's inability to use this facility.</p> <p>When a bidder submits electronic bid through the PPMO e-GP portal, it is assumed that the bidder has prepared the bid by studying and examining the complete set of the Bidding documents including specifications, drawings and conditions of contract.</p> </li> </ol>
ITB 15	<p>The deadline for Sealed Quotation submission is: 06-02-2025 12:00</p> <p>Address: Malepatan Kaski</p>

ITB 18	<p>The bid opening shall take place at : Address :<a href="https://www.bolpatra.gov.np/egp">https://www.bolpatra.gov.np/egp</a> Date and Time:06-02-2025 14:05</p> <p>a) e-GP system allows to download the bid response document only after bid opening date and time are met. Simultaneous login of two members of the opening committee is required for bid opening. b)The Employer shall conduct the opening of bid at the address on the same date and time as specified in bidding document in the presence of Bidders' representatives who choose to attend</p>
--------	--

**Section - III**  
**Eligibility Criteria**

### **Eligibility Requirements**

**All Bidders shall submit following documents as pre- requisites for eligibility:**

- 1 Firm/Company Registration Certificate
- 2 PAN/VAT Registration Certificate
- 3 Tax Clearance Certificate/ Extension Letter/Tax return submission evidence for the F/Y
- 4 Self Declaration of being eligible for given work

#### **Notes to Bidders :**

**The information to be filled in by Bidders in the following pages shall be used for purposes of eligibility as provided for in Clause 2of the Instructions to Bidders. This information shall not be incorporated in the Contract. Attach additional pages as necessary.**



**Section - IV**  
**Bidding Forms**

# Letter of Bid

**The Bidder must accomplish the Letter of Bid in its letterhead clearly showing the Bidder's complete name and address.**

Date: .....

Name of the contract: .....

Invitation for Bid No.: .....

To: .....

We, the undersigned, declare that:

- (a) We have examined and have no reservations to the Bidding Documents.
- (b) We offer to execute in conformity with the Bidding Documents the following Works:
- (c) The total price of our Bid, excluding any discounts offered in item (d) below is:.....
- (d) The discounts offered and the methodology for their application are:.....
- (e) Our bid shall be valid for a period of 45 days from the date fixed for the bid submission deadline in accordance with the Bidding Documents, and it shall remain binding upon us and may be accepted at any time before the expiration of that period;
- (f) If our bid is accepted, we commit to obtain a performance security in accordance with the Bidding Document;
- (g) We understand that this bid, together with your written acceptance thereof included in your notification of award, shall constitute a binding contract between us, until a formal contract is prepared and executed;
- (h) We declare that, we have not been black listed and no conflict of interest in the proposed procurement proceedings and we have not been punished for an offense relating to the concerned profession or business.
- (i) We understand that you are not bound to accept the lowest evaluated bid or any other bid that you may receive; and
- (j) If awarded the contract, the person named below shall act as Contractor's Representative:
- (k) We agree to permit the Employer/DP or its representative to inspect our accounts and records and other documents relating to the bid submission and to have them audited by auditors appointed by the Employer.

Name: .....

In the capacity of .....

Signed .....

Duly authorized to sign the Bid for and on behalf of .....

Date .....

# Bid Security

Bank Guarantee

**Bank's Name, and Address of Issuing Branch or Office**

**(On Letter head of the Commercial bank or any Financial Institution eligible to issue Bank Guarantee as per prevailing Law)**

Beneficiary: ..... name and address of Employer.....

Date:.....

Bid Security No.:.....

We have been informed that . ..... **[insert name of the Bidder]** (hereinafter called "the Bidder") intends to submit its bid (hereinafter called "the Bid") to you for the execution of ..... name of Contract ..... under Invitation for Quotations No. .... ("the IFQ").

Furthermore, we understand that, according to your conditions, bids must be supported by a bid guarantee.

At the request of the Bidder, we..... name of Bank. ....hereby irrevocably undertake to pay you any sum or sums not exceeding in total an amount of. . .....amount in figures ..... (. .....amount in words .....) upon receipt by us of your first demand in writing accompanied by a written statement stating that the Bidder is in breach of its obligation(s) under the bid conditions, because the Bidder:

- (a) does not accept the correction of errors in accordance with the Instructions to Bidders (hereinafter "the ITB"); or
- (b) having been notified of the acceptance of its Bid by the Employer during the period of bid validity, (i) fails or refuses to execute the Contract Agreement, or (ii) fails or refuses to furnish the performance security, in accordance with the ITB.
- (c) is involved in fraud and corruption in accordance with the ITB

This guarantee will remain in force up to and including the date .....number.....days after the deadline for submission of Bids as such deadline is stated in the instructions to Bidders or as it may be extended by the Employer, notice of which extension(s) to the Bank is hereby waived. Any demand in respect of this guarantee should reach the Bank not later than the above date.

This Bank guarantee shall not be withdrawn or released merely upon return of the original guarantee by the Bidder unless notified by you for the release of the guarantee.

This guarantee is subject to the Uniform Rules for Demand Guarantees, ICC Publication No. 758.

. . .Bank's seal and authorized signature(s) . . .

**Note:**

The bid security of ..... has been counter guaranteed by the Bank .....on ..... (Applicable for Bid Security of Foreign Banks).

**Section - V**  
**Works Requirements**

# Scope of Work

## Specifications

### **Notes on the Specifications**

A set of precise and clear specifications is a prerequisite for Bidders to respond realistically and competitively to the requirements of the Employer without qualifying or conditioning their Bids. The specifications must be drafted to permit the widest possible competition and, at the same time, present a clear statement of the required standards of workmanship, materials, and performance of the goods and services to be procured. Only if this is done will the objectives of economy, efficiency and fairness in procurement be realized, responsiveness of Bids be ensured, and the subsequent task of bid evaluation facilitated. The specifications should require that all goods and materials to be incorporated in the Works be new, unused, of the most recent or current models, and incorporate all recent improvements in design and materials unless provided otherwise in the Contract.

Samples of specifications from previous similar projects are useful in this respect. The use of metric units is encouraged by the Funding Agency in case of funding assisted projects. Most specifications are normally written specially by the Employer or Project Manager to suit the Contract Works in hand. The available standard specification of works of Ministry of Physical Infrastructure and Transport, DoLIDAR and Other line Ministries can be adopted for respective civil construction works.

There are considerable advantages in standardizing General Specifications for repetitive Works in recognized public sectors, such as highways, urban housing, irrigation, and water supply, in the same country or region where similar conditions prevail. The General Specifications should cover all classes of workmanship, materials, and equipment commonly involved in construction, however it may not necessarily be adequate to be used in a particular Works Contract and may necessitate preparation of Particular (Special) Specifications to amend and or supplement the provision of the General Specifications to meet the requirement of the particular Works.

Care must be taken in drafting specifications to ensure that they are not restrictive. In the specification of standards for goods, materials, and workmanship, recognized international standards should be used as much as possible. Where other particular standards are used, whether national standards of Nepal or other standards, the specifications should state that goods, materials, and workmanship that meet other authoritative standards, and which ensure substantially equal or higher quality than the standards mentioned, will also be acceptable.

Employers should decide whether technical solutions to specified parts of the Works are to be permitted. Alternatives are appropriate in cases where obvious (and potentially less costly) alternatives are possible to the technical solutions indicated in the Procurement Documents for certain elements of the Works, taking into consideration the comparative specialized advantage of potential bidders. For example:

The Employer should provide a description of the selected parts of the Works with appropriate references to Drawings, Specifications, Bill of Quantities, and Design or Performance criteria, stating that the alternative solutions if applicable shall be at least structurally and functionally equivalent to the basic design parameters and specifications.

Such alternative solutions shall be accompanied by all information necessary for a complete evaluation by the Employer, including drawings, design calculations, technical specifications, breakdown of prices, proposed construction methodology, and other relevant details.

Sample Clause: Equivalency of Standards and Codes Wherever reference is made in the Contract to specific standards and codes to be met by the goods and materials to be furnished, and work performed or tested, the provisions of the latest current edition or revision of the relevant standards and codes in effect shall apply, unless otherwise expressly stated in the Contract. Where such standards and codes are national, or relate to a particular country or region other authoritative standards that ensure a substantially equal or higher quality than the standards and codes specified will be accepted subject to the Project Manager's prior review and written consent. Differences between the standards specified and the proposed alternative standards shall be fully described in writing by the Contractor and submitted to the Project Manager at least 30 days prior to the date when the Contractor desires the Project Manager's consent. In the event the Project Manager determines that such proposed deviations do not ensure substantially equal or higher quality, the Contractor shall comply with the standards specified in the documents.

These Notes for Preparing Specifications are intended only as information for the Employer or the person drafting the Procurement Documents. They should not be included in the final documents.

## TECHNICAL STANDARD

This Section contains the Specification, and the Drawings that describe the Works to be procured.

<p><b>1. General</b></p>	<p>1.1 These specifications together with the Construction Standards shall govern the performance of the Works and shall be the basis for inspection and acceptance of the Works by the NEA.</p> <p>1.2 These specifications and the Construction Standards shall be considered as mutually inclusive, and the conditions stated in each shall supplement the other as appropriate.</p> <p>1.3 All these specifications shall be followed at all times by the Contractor unless specifically accepted in writing by the NEA, or unless some aspects of the work covered by these specifications are not required by the scope of work.</p>
<p><b>2. Route of Circuits</b></p>	<p>2.1 The line routes shown on line route drawings are provisional and subject to finalization by the Contractor. To the greatest extent practicable, all overhead circuits should be located along streets or traveled ways ordained by the Village Development Committee or required authority as public property, except as required for service drops and circuits to individual consumers.</p> <p>2.2 To the greatest extent practicable, all facilities should be located on public property, and in no case shall private property be occupied unless specifically authorized by the NEA. <i>Community shall be responsible for providing right of way.</i></p>
<p><b>3. Surveys and Staking</b></p>	<p>3.1 All structures should be located at the outer limits of public property along streets or travelled ways. Structures should also be located along streets at property lines of adjacent private property. Structures and stays running parallel or perpendicular to the line route shall not block portions of streets, travelled ways, drives, passages, or gates.</p> <p>3.2 All structures shall be so located as to reduce, to the greatest extent practicable, obstacles to pedestrian and vehicular traffic.</p> <p>3.3 Where underground facilities are indicated by surface conditions, or where such facilities can be located, structures and stays shall be so located as to avoid conflict with such facilities during construction.</p> <p>3.4 All structure and stay lead locations shall be staked. At points of intersection (PI) of tangent line sections, steel rebar stakes shall be used to locate the PI. A minimum of two (2) side sightings will be made at each PI to permit re-location of PI in the event of stake removal. All structure locations in tangent line sections shall be staked.</p> <p>3.5 All distances between structures, and other necessary measurements of length, shall be measured to accuracy of 0.1 meter and all angles shall be determined by transit to an accuracy of 0.1 decimal</p>

	<p>degree. All elevations shall be measured to an accuracy of 0.1 meter by means acceptable to the NEA.</p> <p>3.6 All measuring and staking activity shall be accomplished by personnel with experience in survey procedures; and standard survey equipment acceptable to the NEA, shall be used to perform the survey work. Field survey notes covering all survey work shall be produced and maintained and shall be returned to the NEA at the time of submission of final PCS report. The format of proposed survey notes shall be submitted to the NEA for approval.</p> <p>3.7 Survey work shall include centerline and structure location and staking; determination of overhead and side clearings of other structures, wires, and obstacles; area surveys and plotting; and centerline profiles of terrain; as directed by the NEA.</p>						
<p><b>4. Technical Documentation</b></p>	<p>4.1 All technical documentation as specified herein shall be prepared by the Contractor. The Contractor shall employ skilled drafting personnel to produce all documentation specified. All technical documentation prepared by the Contractor shall be subject to the approval of the NEA prior to acceptance by the NEA of such documentation. All technical documentation shall be prepared in the English language.</p> <p>4.2 Documentation shall be prepared using the following mediums:</p> <p>(a) A4 Size of paper shall be used to produce the base Structure Data Sheet (SDS) and A1 size of drawing papers for As-Built Drawings and other drawings specified by the NEA. The scale for drawing shall be 1:5000.</p> <table data-bbox="683 1176 1372 1265"> <tr> <td>A1</td> <td>594 mm x 841 mm</td> <td>(23.39" x 33.11")</td> </tr> <tr> <td>A4</td> <td>210 mm x 297 mm</td> <td>(8.27" x 11.69")</td> </tr> </table> <p>(b) Computerized geographical information system shall be used to produce small area plotting, profiles of line-sections and centerline plotting necessary for the development of SDS and As-Built Drawings.</p> <p>(c) A set of digitized data on CD shall be submitted separately.</p> <p>4.3 SDS shall be prepared as specified in <i>Vol I, Preamble to Price Schedules</i> by the Contractor showing his proposed construction details for erection of facilities in accordance with the Construction Standards. The SDS shall be prepared after the centerline survey and staking is completed, for any line section designated by NEA, and shall be submitted to NEA for approval prior to any construction of the facilities shown in SDS. Submission of SDS for approval shall be in A4 size paper</p> <p>NEA may require any revisions to be made, at their sole discretion, prior to approval of the SDS for construction. An approved and field checked SDS is required for all Construction Units invoiced by the Contractor. The Contractor and NEA representative shall perform Field checking of the SDS jointly. The SDS and As Built Plan are intended as permanent records for NEA. Any construction performed prior to the Contractor's receipt of approved SDS from</p>	A1	594 mm x 841 mm	(23.39" x 33.11")	A4	210 mm x 297 mm	(8.27" x 11.69")
A1	594 mm x 841 mm	(23.39" x 33.11")					
A4	210 mm x 297 mm	(8.27" x 11.69")					



	<p>NEA shall be completely at the Contractor’s risk, and NEA shall have the right to require any correction due to the un-approved construction activities.</p> <p>4.4 As-Built Drawings shall be prepared by the Contractor in the general format provided by the NEA. Drawing size shall be approximately 841 x 594 mm overall and the scale shall be 1:5000. The NEA shall provide any available environmental background data for inclusion on the various drawings and the Contractor shall record (in ink) all facilities As Built.</p> <p>4.5 The Contractor shall prepare other technical drawings, in the same medium and format as the As-Built Drawings, for example As-Built Drawings index sheets, pole maps, and one line diagrams as specified and required by the NEA.</p> <p>4.6 The Contractor shall prepare and furnish Transformer Record documents, in the format specified by the NEA, for each transformer installed.</p>
<p><b>5. Material Storage</b></p>	<p>5.1 The Contractor shall be responsible for storage of all materials and equipment delivered by him for the work; and security of materials. The Contractor shall manage all labor, equipment, and vehicles to load and transport said materials and equipment to the worksites.</p> <p><b>5.2 Worksite</b></p> <p>(a) Extended storage of materials along the routes of lines will not be permitted.</p> <p>(b) Conductor reels may be spotted at the worksites for a short period prior to installation provided that crating and reel lagging are intact to protect the items. Poles may be spotted at structure locations for short periods prior to setting.</p> <p>(c) All poles, and conductor placed at the worksites shall be located so that the items are not subject to damage and do not impede pedestrian or vehicular traffic.</p> <p>(d) Any damage caused by imprudent placement of equipment and materials by the Contractor at the worksites shall be corrected by the Contractor, in a manner acceptable to the NEA, at the Contractor’s cost.</p> <p><b>5.3 Contractor's Storage Facility</b></p> <p>The Contractor shall be financially responsible for the secure and proper storage of materials, prior to installation of the materials and equipment, to prevent loss or damage to any materials. However Contractor may use NEA sub-stations premises subject to approval of concern NEA/Substation Authorities.</p>
<p><b>6. Poles and Cross Arms</b></p>	<p>6.1 Pole Numbering</p>

Poles and structures shall be numbered in accordance with a numbering system provided by NEA. Each pole shall be marked permanently through template with the assigned number.

**6.2 Pole Framing**

Pole and structures shall generally be framed in accordance with Construction Standards and the construction SDS. Where special framing requirements are necessary, the Site Engineer or Engineer shall provide framing instructions for the specific structure.

Each cross-arm shall be attached to the pole by a pole clamp or by machined bolts of sufficient length to pass completely through the holes provided on the pole and cross-arms and receive their full complement of nuts.

Bolts of proper length shall be used. Excess nuts shall not be used to make use of a bolt, which would otherwise be too long. The end of a machined bolt projecting more than 3 centimeters beyond the nut shall be cut off to a length of 2 centimeters beyond the nut. Each bolt, when installed, shall have its full complement of nuts.

Washers shall be used where specified in these standards. For wooden pole, bolted connection through wood members should be drawn tight to allow for shrinkage of wood. Bolts should be pulled up so that the wood is compressed but not so tight to break the wood fibers. Fiber breaks on the surface of the pole increases probability of decay.

During the erection work at the field there may be necessity to modify galvanized steel hardware and may have to be drilled, reamed, filed or cut. Under such a condition the area of the steel exposed, after these modifications, shall be coated with a zinc-rich paint to protect the steel from corrosion.

**6.3 Excavation**

All excavations made for the installation, or demolition, of facilities shall be accomplished in a timely manner according to the scheduled installation. Required excavations shall be opened, material installed, and backfill placed, as specified, in a continuing operation to the greatest extent practicable.

Any excavation left open during discontinuous construction, which is accessible to the public or along public thoroughfare, shall be covered or barricaded, and marked by suitable visual means, to prevent a public hazard.

Excavations shall be properly located and sized for the intended use. Pole and stay plate/ anchor excavations shall be correctly sized to retain undisturbed soil to the greatest extent consistent with the means of excavation. Pole holes shall be made by power-driven auger or by manual methods; power-driven shovel equipment shall not be used. Pole holes shall be excavated to the specified depth with no tolerance shallow and tolerance of ten (10) centimeters deep. The bottom of pole holes shall be undisturbed soil, gravel or rock. Stay plate holes shall be excavated by manual methods to

specified depth with no disturbed soil in the direction of the anchor rod.

All excavations shall be backfilled with excavated material, or as specified for the installation. Backfill shall be free of foreign materials and shall be well tamped with excess backfill graded over the excavated area to prevent depressions resulting from eventual natural compaction. The Contractor if so directed by NEA shall remove large amounts of excess backfill from the site. If so directed by NEA, the Contractor shall provide suitable backfill materials for excavations where existing removed materials is insufficient, or inappropriate, to provide suitable grading of the excavated area.

#### **6.4 Pole Setting**

Poles shall be set in accordance with the appropriate Sections of the Construction Standards.

Each pole shall be assigned a unique construction number at the time of structure staking for preliminary identification and preparation of SDS.

Pole holes shall be dug large enough in diameter to admit a tamping bar all around the periphery of the pole and shall have a uniform dimension as per the type of pole used at the top and bottom. Poles shall be planted in the ground to the depth specified in construction. Drawings before planting a pole, the bottom of the hole made for planting the pole, shall be cleaned of free soil and firmly tamped, to prevent the hole from settling.

The stability of a pole, particularly a pole without stay, is greatly influenced by the size of the pole hole, the nature of the soil and the care exercised in back filling and tamping. Two active hand tampers and one slow shovel shall result in good compaction.

Poles shall be set to stand perpendicular except at terminals, angles and other points of excessive strain where they shall be given a rake not to exceed 10 centimeters against the direction of strain. Poles located at the sides of banks or other locations, where washouts may occur, shall be protected by suitable cribbing, or shall be referred to the Engineer for recommended action.

After the pole is in position and the hole is back filled and tamped, soil shall be piled and packed firmly around the pole. Pole setting shall be inspected prior to acceptance and any back fills that have sunk shall be refilled.

Where it is necessary to set poles at locations where the soil has very low bearing value, or in swampy conditions, a pole may be fitted with a bog shoe in accordance with construction drawings the engineer may specify that type of construction.

Poles located in shallow riverbeds shall be protected by gabions as designated by the Site Engineer or Engineer. Gabions should be approximately 2 meters x 1 meter x 1 meter. Four such gabions are required for each pole.

	<p>Set pole and pour 860 mm diameter foundation as per construction standard construction drawing. Level areas around pole and set gabions in pattern shown in construction drawing. It is important to lace adjacent gabions together along the perimeter of all contact surfaces. Fill gabions with hard, durable, clean stone, 100 mm to 200 mm in size in three layers. Install two connecting wires at each layer. Lace gabion lids securely making certain all edges are closed. Fill void between pole and gabion with hard, durable, clean rock 200 mm minimum size.</p>
<p><b>7. Stays</b></p>	<p>7.1 Stay leads specified in construction documents are defined as the horizontal distance from the centerline of the pole at ground line to the point where the anchor rod should enter the ground assuming the ground to be level. For the correction in stay leads for uneven ground see construction drawing.</p> <p>The Engineer, upon request, may designate the actual location of stay anchor rods on slope of hills. The stay stake indicates the point where the anchor rod enters the ground. The anchor hole shall be dug accordingly.</p> <p>The attachment of one stay shall not overlap that of another stay when 2 or more stays are carried to a pole or anchor. Each shall be entirely independent of the other. This does not prevent the use of multiple eye rods for nuts designed for such use.</p> <p>All stays to be installed on a pole line shall be placed and drawn reasonably taut before the conductors are tensioned. After the conductors are tensioned and sagged to their final position, the stays shall be carefully inspected to see that each is carrying its share of the load on the pole as intended. If multiple stays are not carrying equal strain, the slack stay shall be pulled up until it is sharing load as intended.</p> <p>Stay anchors must be installed full depth and set to pull against undisturbed soil to develop full tension. An anchor not properly installed will move and allow movement of the top of the pole, thus slacking the conductors. Stay anchors installed in soft or unstable earth shall be placed at specified depth and back filled with 5 cm. maximum size crushed stone placed to a depth of 1 meter from the bottom of the pole.</p> <p><b>7.2 Installation of Stays</b></p> <p>Where stays are installed on a line angle structure, line of stay shall bisect the outside line angle.</p> <p>The span of stay extending between poles shall not be greater than 60 meter.</p> <p>Anchor and anchor rods shall be set so that the axis of the rod and line of stay shall be straight. The portion of the anchor rod above the ground shall not be bent at an angle to connect a stay wire. If this occurs, anchor and anchor rod shall be reset. The anchor rod shall not be exposed for more than 15 centimeters above the ground after the anchor is set.</p>

	<p>If gravel back fill is required to set anchor in soft or unstable soil, as per construction drawing the Contractor will have to carry out the gravel back fill as directed by Engineer.</p> <p>If a stay is installed on a pole where low voltage conductor is dead ended or double dead ended and extends past stay, a piece of plastic hose slit along the length shall be placed over the stay wire extending from the upper stay attachment to 200 mm below lowest low voltage conductor. After installation, the hose shall be wrapped with plastic tape and the hose shall be secured to the upper stay bolt with tie wire.</p> <p><b>7.3 Stay Insulators</b> Stay insulators shall be installed on all stays in accordance with the construction drawings</p>
<p><b>8. Conductor</b></p>	<p>Aluminum Conductor Steel Reinforced (ACSR) conductor shall be used for 11,0.4/0.23 kV overhead lines.</p> <p><b>8.1 Sagging</b> Conductors shall be sagged in accordance with the sag chart specified by these specifications.</p> <p>The importance of careful sagging of conductors cannot be over emphasized. Conductors have definite characteristic that control their behaviour resulting from changes of temperature, wind speed and additional load due to ice or wet snow.</p> <p>Conductors must not be sagged too tightly (less than specified sag) as unspecified extra tensions may result in failure of conductor structure.</p> <p>Conductors sagged too loosely (more than specified sag) may contact adjacent conductors hardware or any structure. Excess sag can reduce clearance beneath the line with the ground to the point of danger.</p> <p><b>8.2 Sag Charts</b> Unless otherwise noted, all sag charts are calculated on the basis of 35 kg/m<sup>2</sup> wind pressure</p> <p>Sag is always measured vertically, without wind, when conductors are being installed or re-sagged.</p> <p>Unless otherwise specified by the Site Engineer or Engineer for a specific condition, initial or stringing sag shall be applied to the installation of all new unstressed conductors. The initial sag is always less than the final sag. The most practical method of obtaining the correct sag is by sighting between two adjacent structures. Choose the structure, which is reasonably near the same elevation</p> <p>Sags for the various temperatures shall be furnished by the Engineer in a table form for spans not covered by the sag chart.</p>

In order to ascertain the sag for a given stringing temperature, select the point corresponding to the proper temperature on the scale on the left-hand side of the sag chart. Lay a straight edge so that it passes through this point and the point of the centre scale representing the length of span to be sagged. The straight edge will then indicate the proper stringing sag on the right-hand scale. Interpolate if the temperature of span is not exactly the same as designated on the chart. The low voltage neutral conductor shall be sagged with the same sag as the low voltage phase conductor. If the low voltage conductor, as a group, has less design sag than the high voltage phase conductor installed above it, the low voltage conductor, as a group, shall be installed to the same sag as the high voltage conductors installed above. The sag of pre stressed conductors such as installed with a tensioning machine shall be specified by the Engineer for the job.

### **8.3 Stringing**

All cable grip used for the installation of conductors shall be of the type designed to prevent injury to the conductor.

Attach targets to each structure at a distance below each point of the support of conductor equal to the required sag. Sight from one target to the other. The line of sight between targets may be horizontal or inclined. Draw the conductor up to the proper sag, which will be reached when its lowest point will be in line with the target.

Where terrain and / or length of span is such that the targets would fall below the ground line, the difference in elevation between the lower conductor attachment and the lowest point of sag, sag below lowest support will be furnished by the engineer in the tabular form.

The dynamometers and similar apparatus shall be used for tensioning of conductor to obtain appropriate sagging of conductors. Dynamometer shall be used only when the sight method is not feasible. Dynamometer shall be checked for accuracy before using.

For stringing of ACSR conductors of all sizes, stringing rollers or roller shall be used to support the conductor as it is pulled out and sagged. Stringing rollers shall be used regardless of size of aluminium conductors, bare or covered.

Stringing rollers shall be suspended at each insulator support position so that the conductor shall roll smoothly over the roller-protecting conductor from any physical damage.

Stringing sheaves shall have a diameter at least 20 times the conductor diameter and so finished as to prevent damage of any kind to the conductor as it is pulled through the sheaves.

Conductor drum shall be located at a sufficient distance from the first structure to avoid excessive bending of the conductor over the sheaves and excessive downward loading on the cross-arms.

Attention shall be paid to the fact that all sag charts contained herein for ACSR conductors are calculated on the basis of non-pre-stressed conductor. For this reason, at no time during the stringing or sagging operation, shall conductors of this type be pulled to sag, which are less than those shown by the charts.

Special care shall be taken at all times to prevent the conductor from becoming kinked, twisted or abraded in any manner. Where it is necessary to drag conductors on the ground, the conductors shall be protected by covering all stones or other objects, which might damage the conductor with boughs or trees or suitable pieces of lumber. These requirements are especially important when ACSR conductor is being handled on river crossing spans. Floats with rollers shall be used to prevent the conductor from dragging along the river bottom.

In stringing conductors across highways, the conductors shall be fully protected from passing vehicles by use of temporary guard structures.

**8.4. Damaged Conductor**

Damaged conductors shall be repaired by using a repair sleeve provided that no more than 2 strands of the outer aluminium layer are damaged and further provided that none of the sleeve core strands are damaged. For a conductor damaged in excess of the above conditions, the damaged section of the conductor shall be cut out and a tension splice installed.

When cutting out damaged section of conductor, no more than 1 tension splice shall be permitted in a span and no splice is made within 8 meters of an insulator attachment.

**8.5 Sag Error**

Sag error shall not exceed  $\pm 40$  mm from the sag defined by the sag chart.

**8.6. Conductor Attachment**

Conductors shall be secured to pin insulators with pre-formed conductor ties or with tie wire. Insulator ties, except at jumper supports in structures, shall be made with pre-formed ties when available.

Conductors shall be connected to dead end assemblies with tension set.

**8.7 Line Splices for Tensioning and Looping**

Cleaned and polished contact surfaces are necessary to make conductor splices so that it shall remain free from trouble. Great care shall be taken to completely clean the strands of aluminum conductor. The splicing sleeve must be centered over the conductor ends before compressing to make a splice of required strength.

Appropriate sleeve shall be used for splicing ACSR conductors prior to installation. The outer strands of aluminum shall be carefully

cleaned with a wire brush to remove all foreign matter till the aluminum shines brightly. The cleaning applies to both new and old conductors. The manufacturer pre-filled with inhibitor compound supplies splicing sleeves for aluminum conductor.

Splices in line conductors shall be so located that the end of the splicing sleeve is at least 30 cm from the end of a suspension or dead end clamp. Non-tension loops, such as between dead ends, shall be spliced with a connector when the conductors are of same metal and size.

#### **8.8 Connectors**

Cleaned and polished contact surfaces are necessary to make electrical connections that will be free from trouble.

Tap connectors are supplied by manufacturers pre-filled with inhibitor compound. Excess inhibitor compound shall not to be removed but it shall be wiped over the connector as a moisture seal. Connectors shall not be covered or taped.

Compression connectors shall be located in such a manner that there shall be at least 30 cm of conductor between the end of the connector and the end of a dead end

Connectors shall be installed on non-tensioned portion of the conductor such as loops in preference to the conductor in the span.

Connectors installed on conductor shall be located in a span adjacent to the crossing rather than the crossing span when practicable.

Aluminum compression connectors, pre-filled with inhibitor compound, shall be compressed on the cleaned area of aluminum conductor. Where necessary, inhibitor compound shall be applied to the cleaned conductor and connector before assembly.

Aluminum compression connectors shall be used for connecting aluminium-to-aluminium conductors.

#### **8.9 Conductor Accessories**

##### **Pre-Formed Ties and Grips**

Taps for jumpers and services shall not be made over the legs of ties or dead end grips.

##### **Pin Insulator Ties**

Pin insulator ties are of 2 types:

- a. With single top grooves: Single top ties may be used to turn line angles to 7 degrees where single insulators are permitted. Please refer construction drawing for specific applications.
- b. With side grooves with specific size of ties for specific conductor in each tie style: Specific usage is dictated by



insulator pin loading and use of single insulators as specified in construction drawing.

#### **Shackle Insulator Ties**

Shackle insulator ties are furnished in one type with specific size of ties for specific conductor. Shackle ties may be used to turn line angles at 20 degree. At the line angles, the conductor shall be located on the side of the vertically installed shackle insulator that causes the conductor to be forced against the shackle insulator. Angle loading shall not be imposed on the ties itself.

#### **Preformed Stay Wire Binder**

Preformed stay wire binder for stay wire are furnished as per construction drawing.

Preformed stay wire binder are right hand lay. Preformed stay wire binder may be removed and replaced up to 3 times, when initially installed, to permit adjustment of stay tension.

When applying ties or grips the manufacturer's identification tag and colour coding shall be checked to insure that the tie or grip is the right unit specified for application on the specific conductor or wire strand.

Perform for stay wire are furnished with 2 crossover markings. When applying preform on hardware, the grip shall be installed using the crossover point closest to the loop of the grip.

#### **Compression Fittings**

Full-tension conductor splices and repair sleeves are furnished for all conductors to be installed.

##### **a. Full Tension Conductor Splice**

Full-tension spliced for ACSR conductor is provided in a 2/1-piece unit. Full tension conductor splices will develop full conductivity of the conductor and a minimum of 95% of the rated conductor breaking strength. Please see construction drawing for splicing instructions.

##### **b. Repair Sleeves**

Conductor repair sleeves are furnished for all conductors to be used to restore the rated current carrying capacity of conductors with broken strands. Repair splices have no tension rating.

#### **8.10 PG Clamps**

PG clamps are furnished in a full range of sizes for application in the non-tension connection in 33, 11 kV circuits. The PG clamps are designed for general use in making tap and jumper connections of various types.

In all applications of PG clamp fittings, the conductor metal shall be wire-brushed to a bright condition to remove surface oxidation on the conductor.

**8.11 Application**

When applying ties or grips the manufacturer's identification tag and colour coding shall be checked to insure that the tie or grip is the right unit specified for application on the specific conductor or wire strand.

Preformed for stay wire are furnished with 2 crossover markings. When applying preformed on hardware, the grip shall be installed using the crossover point closest to the loop of the grip.

In all applications of PG clamp fittings, the conductor metal shall be wire-brushed to a bright condition to remove surface oxidation on the conductor.

**8.12 Line Construction**

**Arrangement of Conductor**

The standard position of 33, 11 kV phase conductors on the cross-arm in the normal triangular configuration looking from the normal source of power supply shall be seen as:

Red (R) on top of the pole, Yellow (Y) on right hand end of the cross-arm and Blue (B) on left hand end of the cross arm.

**Attachments to Poles**

Boltholes are provided on poles for cross-arms, cross-arm braces and stay bolts.

**Conductor Ties**

Pre-formed ties and grips shall be used for attaching conductors to structures when available.

If pre-formed materials are not available, the wire shall be soft conductor so that when made up, the tie wire will bind the conductor tightly. No tie wire shall be used for a second time.

Tie wire shall be of the same metal as that of the bare conductor to which the tie is applied.

**Conductor Support**

The conductor supports on straight lines shall be carried on the top wire groove of the pin insulator. Conductors shall be attached to the side conductor groove of pin insulator on the outside of angles so that transverse conductor tension will tend to hold the conductor in the insulator groove.

Conductor ties shall not hold a conductor on the insulator when uplift exists. If uplift is found, it is required to consult with the Site Engineer or the Engineer to determine remedial action to be taken.

**8.13 Pole Wiring**

All taps or connections passing from one level to another on the pole shall, as far as possible, be vertical. Connections shall have sufficient length so that the line conductors are not moved from normal positions and normal movement is not restricted. Connections shall

	<p>have at least 30 centimetres clearance from other conductors. Any connection carried from one side of the pole to the other side shall be supported on pin insulators.</p>												
<p><b>9. Transformer Structures</b></p>	<p>Distribution panel-board material and equipment ratings shall be determined by the kVA rating of the transformer and number of 400/230 volt out going distribution circuits.</p> <p>Where out going distribution circuits are installed, pole moment loading must be balanced by another out going distribution circuits in the opposite direction or by installation of stays.</p> <p>Two separate rods shall be used to earth the transformer structure</p> <p>a.) One for surge arresters and equipment</p> <p>b) Another for the neutral of transformer low voltage winding, body of transformer and the body of MCCB box.</p> <p>Each earth rod shall be driven at a minimum distance of 2 meters from the adjacent pole resulting in a minimum distance of 6 meters between the two ground rods.</p> <p>Ground conductor lead shall be stranded steel wire.</p> <p>1/2" banding material shall be used to strap grounding conductors to pole(s) at one (1) meter intervals.</p> <p>Compression connectors and PG clamp shall be used to make all electrical connections. When connecting copper transformer circuit conductor to the secondary line conductors, the copper conductor shall be placed below the aluminium conductor at the connection so that rainwater will flow from the aluminum conductor onto the copper conductor.</p> <p>Conductor shall be terminated on main breaker and neutral bus with cable socket of proper size.</p> <p>Individual conductors of the circuits located in panel boards shall be bundled with cotton or nylon cord and trained and tied to conductor standoff clips.</p>												
<p><b>10. Installation Criteria</b></p>	<p>10.1 The line alignment should be as straight as possible to minimize requirements for stays.</p> <p>The basic span shall be maintained within the following limits:-</p> <p>11 kV line: 50m to 55 m</p> <p>Low voltage and composite line:</p> <table border="1" data-bbox="603 1733 1388 1984"> <thead> <tr> <th>S. No.</th> <th>No of wire</th> <th>Span in meter</th> </tr> </thead> <tbody> <tr> <td>1.</td> <td>4 wire</td> <td>35-40</td> </tr> <tr> <td>2.</td> <td>3 wire</td> <td>40-45</td> </tr> <tr> <td>3.</td> <td>2 wire</td> <td>45-50</td> </tr> </tbody> </table>	S. No.	No of wire	Span in meter	1.	4 wire	35-40	2.	3 wire	40-45	3.	2 wire	45-50
S. No.	No of wire	Span in meter											
1.	4 wire	35-40											
2.	3 wire	40-45											
3.	2 wire	45-50											

	<p>10.2 The entire construction works shall be performed as per the construction units specified. Whenever the construction unit does not cover any specific activity, the Contractor and the NEA shall mutually settle the cost as per the man-hour involvement for the same and according to the labour rate quoted by the Contractor in his Bid.</p> <p>10.3 Detailed schedules of material to be used are provided in each structure drawing of the construction standards. It shall be the responsibility of the Contractor to judge the appropriateness of the listed material according to the site conditions. If there is any need for addition/reduction or deviation from the listed material size/quantity, the Contractor shall ask the NEA for the approval of the same.</p> <p>10.4 All types of line clearances shall be maintained as per the construction standards provided to the Contractor. Deviations from the standards may be allowed only for unique or special conditions.</p> <p>10.5 Safety rules of the NEA shall be strictly observed at all times by the NEA and the Contractor and their personnel. Special care shall be taken to maintain the optimum conductor sag to provide adequate safety to the construction and the property or people.</p> <p>10.6 All fastenings (e.g. preforms, nut bolts, stays and the like) shall be so installed that the constructed line components shall not fail to remain within the safety margin while maximum working load is applied.</p> <p>10.7 If the Contractor requires clarification of any construction standard or unit or he feels any doubt in his interpretation of construction activities he should clarify the points with the NEA in writing and the decision thus made shall be valid for further work.</p> <p>10.8 HV Insulators: The Contractor shall use HV pin insulators in the alignment of the line where the break angle does not exceed the limits provided hereafter,</p> <table border="1" data-bbox="603 1462 1388 1722"> <thead> <tr> <th>S. No.</th> <th>Conductor Size in mm<sup>2</sup></th> <th>Minimum Break Angle in Degrees</th> </tr> </thead> <tbody> <tr> <td>4.</td> <td>100 (Dog)</td> <td>7</td> </tr> <tr> <td>5.</td> <td>50 (Rabbit)</td> <td>15.5</td> </tr> <tr> <td>6.</td> <td>30 (Weasel)</td> <td>24.5</td> </tr> </tbody> </table> <p>In the case where the break angle exceeds the above values the Contractor shall make dead end at the angle structure and use disc insulator fittings.</p>	S. No.	Conductor Size in mm <sup>2</sup>	Minimum Break Angle in Degrees	4.	100 (Dog)	7	5.	50 (Rabbit)	15.5	6.	30 (Weasel)	24.5
S. No.	Conductor Size in mm <sup>2</sup>	Minimum Break Angle in Degrees											
4.	100 (Dog)	7											
5.	50 (Rabbit)	15.5											
6.	30 (Weasel)	24.5											
<p><b>11. Installation of Stays</b></p>	<p>11.1 The Contractor, in general, shall install at least one stay for the supports in the following cases</p> <p>(a) Dead end structure</p> <p>(b) Tee-off (Tap) structure</p>												

	<p>11.2 Stay may not be installed in the following conditions</p> <p>HV Line (11 kV) with 11 m Pole</p> <p>a) - Conductor 3x100 mm<sup>2</sup>  - Span 75 m (max)  - Break angle: 4 deg.</p> <p>b) - Conductor 3x50 mm<sup>2</sup>  - Span 75 m (max)  - Break angle: 5.5 deg.</p> <p>c) - Conductor 3x30 mm<sup>2</sup>  - Span 75 m (max)  - Break angle: 6.5 deg.</p> <p>Composite (HV +LV) line with 11 m pole</p> <p>a) - Conductor 3x100 mm<sup>2</sup> HV; 3x50 mm<sup>2</sup>+30 mm<sup>2</sup> LV  - Span 40 m (max)  - Break angle: 2 deg.</p> <p>b) - Conductor 3x50 mm<sup>2</sup> HV; 3x30 mm<sup>2</sup>+1x30 mm<sup>2</sup> LV  - Span 50 m (max)  - Break angle: 2.5 deg.</p> <p>For conditions different from the above, the Contractor shall provide calculations showing the number of stays necessary and get approval from NEA prior to installation.</p>
<p><b>12. Transformer Mounting</b></p>	<p>Each transformer (except single phase pole mounted) shall be so mounted on the platform that the centre of the transformer is in the middle of the platform. Deviations are not permitted from this rule.</p>
<p><b>13. Grounding Procedure</b></p>	<p><b>13.1 Purpose</b></p> <p>Grounding conductors and electrodes (ground rods) are installed on poles and structures to provide a low impedance path to ground for fault currents and over voltages and current waves initiated by lightning strokes. The objective is to minimize possible difference in potential between normally non-current carrying parts and from those parts to ground. It is also necessary to provide a current path to ground to enable protective devices to quickly de energize the circuit under over voltages and over current conditions.</p> <p><b>13.2 Parts to be grounded</b></p> <p>The following parts shall be grounded</p>

	<p>a) Surge arrester ground studs</p> <p>b) Normally non-current carrying parts of the switches, frames, panel boards, cabinets, re closer tanks etc.</p> <p>c) Low voltage neutral points of the transformer.</p> <p>d) Neutral for the low voltage (0.4/0.23 kV) line shall be grounded at every 15 poles.</p> <p><b>13.3 Grounding Conductors</b></p> <p>Conductor sizes for grounding of specific parts shall be made as follows.</p> <p>Surge Arrester    2AWG copper welded</p> <p>Switch frames and re closers                                        2 AWG copper welded</p> <p>Transformer neutral points    25 sq mm copper wires</p> <p>All the grounding conductors shall be installed with the high-density polythene pipe at least above reach of the human beings</p> <p><b>13.4 Ground Rod Installation</b></p> <p>At switches, re closers grounding points the ground rod shall be installed in the ground at a minimum lateral distance of two meter from the associated poles. The top of the ground rod shall be driven to a minimum depth of 40 centimetres below grade before connecting the ground conductor to the ground rod.</p> <p>At the transformer structure body of the transformer and the body of surge arrester, MCCB box, the grounds shall be separated laterally from transformer secondary neutral point grounds by a minimum of 6 meters. Ground rods shall be driven to a minimum depth of 40 centimetres below grade before connecting the grounding Conductor to the ground rod.</p> <p>The grounding conductor shall be encased in a rigid plastic pipe for a distance of 3 meters above the top of the concrete pole foundation or collar. The plastic pipe shall be of sufficient internal diameter to contain the grounding conductor.</p>
<p><b>14. Low Voltage Circuits</b></p>	<p>400/230 Volt Low Voltage Circuits</p> <p><b>General Instructions</b></p> <p><b>14.1 General</b></p> <p>Bare wire 400/230 Volt circuits shall be supported on shackle insulator with D-iron. Generally, shackle insulator with D-iron shall be placed on the same side of the pole throughout the length of the</p>

	<p>line. Care shall be taken to see that shackle insulator with D-iron shall be mounted on that side of the pole from where most of the house service connection shall be extended.</p> <p>Spacing between two conductors for low voltage circuit shall be 305 mm.</p> <p>The three low voltage phase conductor shall be located in descending order from the top of the pole with Red (R) on the top, Yellow (Y) below Red and Blue (B) below Yellow. The low voltage neutral conductor shall occupy the bottom position.</p> <p><b>14.2. Neutral Conductor</b></p> <p>Neutral conductor may be the same size as the phase conductor or be sized smaller than the phase conductors. The neutral conductor size shall be specified by the work plan.</p> <p>All neutral conductors shall be bare ACSR.</p> <p><b>14.3 Phase Conductor</b></p> <p>Phase conductors shall be bare ACSR conductor as specified by the work plan.</p>
<b>15 Dismantaling</b>	<p>15.1 Transformer, conductor, poles etc. shall be dismantled and transported safely to the local NEA office.</p>
<b>15. Safety</b>	<p>16.1 The Contractor shall take all measures required to safeguard the public, public and private property from any hazard to life, limb, or property, which may arise during the performance of the construction of the works. Such measures shall include, but not be limited to barricades, signs, newspaper announcements, traffic control by police, or other advisory and control methods deemed appropriate.</p> <p>16.2 The Contractor shall provide his work force with all tools and equipment in sufficient numbers and quality to perform all aspects of the works in a safe manner. The Contractor shall provide protective headgear for all members of his workforce, and shall provide protective clothing as required for specific tasks. The Contractor shall instruct his work Force in proper and safe construction techniques and shall continuously monitor compliance with safety instructions throughout the period of the Contract.</p> <p>16.3 The Contractor shall provide, and require use of, protective grounding equipment when :</p> <ul style="list-style-type: none"> <li>a) Work is being performed on lines adjacent, either in extension of, or parallel to, energized circuits.</li> <li>b) Work is being performed on isolated circuits after conductors have been installed</li> </ul> <p>16.4 The Contractor shall maintain all tools and equipment in good working order. All mechanized equipment shall have adequate safety mechanisms and guards in place and be fully operational.</p>

	<p>Operators of such equipment shall be skilled and fully trained in the operation of such equipment.</p> <p>16.5 The Contractor shall provide and maintain emergency medical supplies to cover with accidents and snakebites for his work force on a readily available basis. The Contractor shall also instruct all supervisory personnel in the action to be taken in the event of serious injury, and the sources and locations of professional medical assistance, which shall be employed in such cases.</p> <p>16.6 The Contractor shall apply all accidental insurance policies to his work force for an accident occurring during the working period of the construction.</p>
<b>17. Tests</b>	<p>17.1 The Contractor shall furnish the electrical test equipment and personnel to perform electrical tests of equipment and circuits, as specified by, and under the supervision of the NEA.</p> <p>17.2 The Contractor shall megger all circuits installed with a motor-driven megger or equivalent instrument to demonstrate the acceptable insulation characteristics of the line prior to energization and Provisional Acceptance. 400/230 V overhead circuits shall be tested at 500 volts AC.</p> <p>17.3 The Contractor shall conduct DC hi-potential tests on all underground circuits, after makeup but prior to backfilling. The test shall be made with DC hi-potential test set capable of non-destructively testing the cable at approximately 300% of cable voltage rating.</p> <p>17.4 The Contractor shall megger all transformers with a motor-driven megger prior to connection to the LV network.</p> <p>17.5 All tests specified shall be conducted during suitable atmospheric conditions under the supervision and witness of the NEA. All test results shall be documented and signed by both parties.</p>
<b>18. Demolition</b>	<p>18.1 The Contractor shall perform the removal of all existing facilities in accordance with the specific directions of the Authorized Personnel. All materials removed shall remain the property of NEA and the Contractor shall deliver all salvaged materials to the NEA warehouse, or as specifically directed by the Branch Chief in writing.</p>
<b>19. Cleanup</b>	<p>19.1 The Contractor shall ensure that all worksites shall be free of all manner of debris resulting from the construction activity.</p> <p>19.2 All crating, conductor reels, packaging materials, conductor scraps, and other miscellaneous items are removed from the workplace. All holes resulting from removal of facilities shall be filled. If trees or brush have been cut or trimmed, all cuttings shall be removed. The worksites shall be left in clean natural conditions.</p> <p>19.3 Site cleanup shall be an integral part of the Provisional Acceptance process, and no line section shall be provisionally accepted unless all cleanup work has been accomplished.</p>
<b>20. Tree Cutting and Trimming</b>	<p>20.1 Any tree cutting or tree trimming shall be accomplished by the Contractor in coordination with CBO.</p>



	20.2 All cutting shall be removed by the Contractor with disposition of cutting as specified by NEA.
<b>21. Interruptions to Existing Service</b>	<p>21.1 The Contractor shall arrange for interruptions of service to existing lines with NEA. Every effort shall be made to limit such interruptions to the minimum.</p> <p>21.2 If it is possible to maintain service to a section of line by constructing temporary facilities approved by NEA, the Contractor shall detail man hours and classification of personnel required to construct such facilities and submit to NEA for approval prior to any work being performed. Payment for approved work shall be based on the rates covered in <i>Vol I, Preamble to Price Schedules, Construction Unit 10</i>.</p>

Note : The Technical Specification described above may be changed as instructed by site Engineer.

**Section - VII**  
**Drawings**

Note:

1. It is customary to bind the drawings in a separate volume, which is often larger than other volumes of the contract documents. The size will be dictated by the scale of the drawings, which must not be reduced to the extent that details are reduced illegible.
2. A simplified map showing the location of the Site in relation to the local geography, indicating major roads, posts, airports, and railroads, is helpful.
3. The construction drawings, even if not fully developed, must show sufficient details to enable bidders to understand the type and complexity of the work involved and the price the Bill of Quantities.

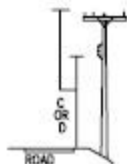
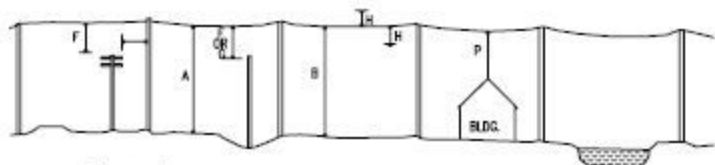

POLES ADJACENT TO ROADS.

CONDUCTORS IN SPAN

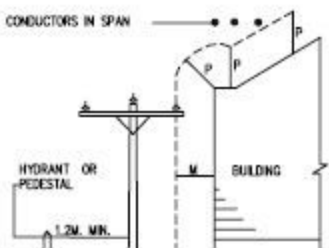

MINIMUM CLEARANCE FROM BUILDINGS.

	CROSSING OVER	VOLTAGE OF CIRCUIT CROSSING	METER
A	ROAD, STREET, HIGHWAY OR LIMITED ACCESS HIGHWAY	230/400 V - 11 KV*	5.80
		11 KV** - 33 KV	8.10
B	AREAS ACCESSIBLE TO PEDESTRIANS ONLY	230/400 V - 11 KV*	4.60
		11 KV** - 33 KV	5.20
LINE ALONG SIDE OF			
C	MAIN HIGHWAYS, STREETS OR ALLEYS	230/400 V - 11 KV*	5.00
		11 KV** - 33 KV	5.80
D	RURAL ROADS NO VEHICLE CROSSING UNDER	230/400 V - 11 KV*	4.60
		11 KV** - 33 KV	5.20

\* Exclude

\*\* Include

LOCATION	VOLTAGE	CLEARANCE (M. MIN)
Min. Horizontal Clearance from Buildings, M	230/400 V - 11 KV*	1.20
	11 KV* - 33 KV	3.00
Min. Vertical Clearance from tallest pt. of Group, Hill or Mt. P	230/400 V	3.00

CLEARANCE M ALSO SPECIFIED HORIZONTAL CLEARANCE FROM BALCONIES.

CONDUCTORS AT LOWER LEVEL	CONDUCTORS AT HIGHER LEVEL	SERVICE DROP 0 - 600 V	OPEN SUPPLY WIRES			STAYS AND SUPPLY CABLES ON GROUND OR MESSAGER
			0 - 600 V	601 - 11000 V	33000 V	
F	COMMUNICATION WIRES	0.60 M.	—	—	—	—
	COMMUNICATION CABLES AND MESSAGER	0.6 M. OVER 1.2 M. UNDER	1.30	2.15	—	0.60
G	SUPPLY CABLES ON EFFECTIVE GROUND MESSAGER	0.6 M. OVER 1.2 M. UNDER	0.80	0.80	—	0.60
H	OPEN SUPPLY 0 - 600 V.	—	1.30	1.80	2.70	0.80
	WIRES 601 - 11,000 V.	—	—	1.20	—	1.20
STAYS SERVICE DROPS 0 - 600 V.		0.60	0.90	1.20	—	—

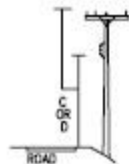
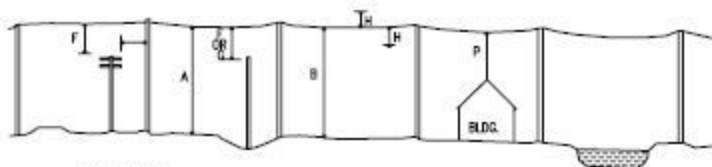

POLES ADJACENT TO ROADS.

CONDUCTORS IN SPAN

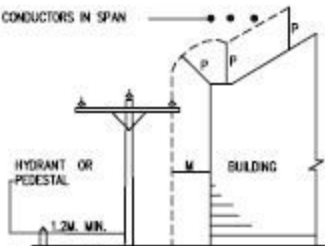

MINIMUM CLEARANCE FROM BUILDINGS.

CROSSING OVER	VOLTAGE OF CIRCUIT CROSSING	METER
A ROAD, STREET, HIGHWAY OR LIMITED ACCESS HIGHWAY	230/400 V - 11 KV	5.80
	11 KV** - 33 KV	8.10
B AREAS ACCESSIBLE TO PEDESTRIANS ONLY	230/400 V - 11 KV	4.60
	11 KV** - 33 KV	5.20
LINE ALONG SIDE OF		
C MAIN HIGHWAYS, STREETS OR ALLEYS	230/400 V - 11 KV	5.20
	11 KV** - 33 KV	5.80
D RURAL ROADS NO VEHICLE CROSSING UNDER	230/400 V - 11 KV	4.60
	11 KV** - 33 KV	5.20

\* Excludes

\*\* Includes

LOCATION	VOLTAGE	CLEARANCE (METER)
Min. Horizontal Clearance from Buildings, M	230/400 V - 11 KV**	1.20
	11 KV** - 33 KV	1.90
Min. Vertical Clearance from lowest pt. of Garage, Hut or Wall, P	230/400 V	3.00

CLEARANCE M ALSO SPECIFIED  
HORIZONTAL CLEARANCE FROM  
BALCONIES.

CONDUCTORS AT HIGHER LEVEL CONDUCTORS AT LOWER LEVEL	SERVICE DROPS 0 - 650 V	OPEN SUPPLY WIRES			SPANS AND SUPPLY CABLES ON DRUMMED MESSAGER
		0 - 650V	850 - 11000 V	33000 V	
F COMMUNICATION WIRES	0.60 M.				
	0.0 M. OVER 1.2 M. UNDER	1.30	2.15	—	0.60
G SUPPLY CABLES ON EFFECTIVE GROUNDING MESSAGER	0.0 M. OVER 1.2 M. UNDER	0.80	0.80	—	0.60
H OPEN SUPPLY 0 - 650 V. WIRES 851 - 11,000 V.	—	1.30	1.80	2.70	0.80
	—	—	1.20	—	1.20
SPTS SERVICE DROPS 0 - 650 V.	0.60	0.90	1.20	—	—

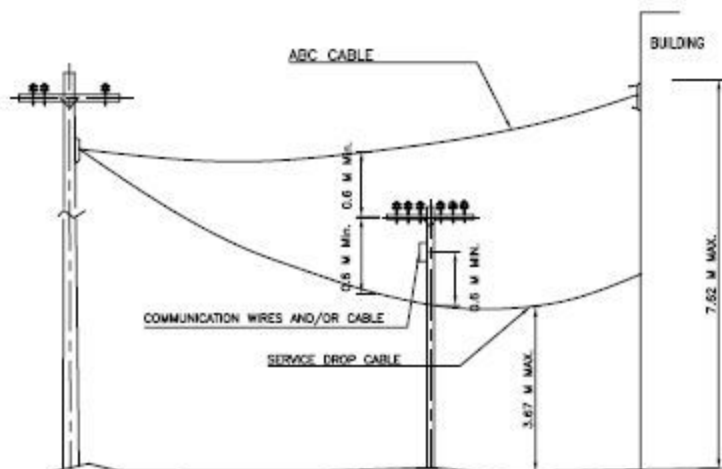

SERVICE DROP

- Install service over communication facilities where practical and attach to pole when available; otherwise cross under communication facilities; with proper clearance.

SERVICE DROP (0-400V) CROSSING OVER	CLEARANCE
DRIVEWAY TO RESIDENCE GARAGE OR OVER PARKING LOT EXCLUDING TRACKS	3.67 M.
DRIVEWAY AND COMMERCIAL PARKING LOT OR AREA SUBJECT TO TRUCK TRAFFIC	4.57 M.

# SAG CHART

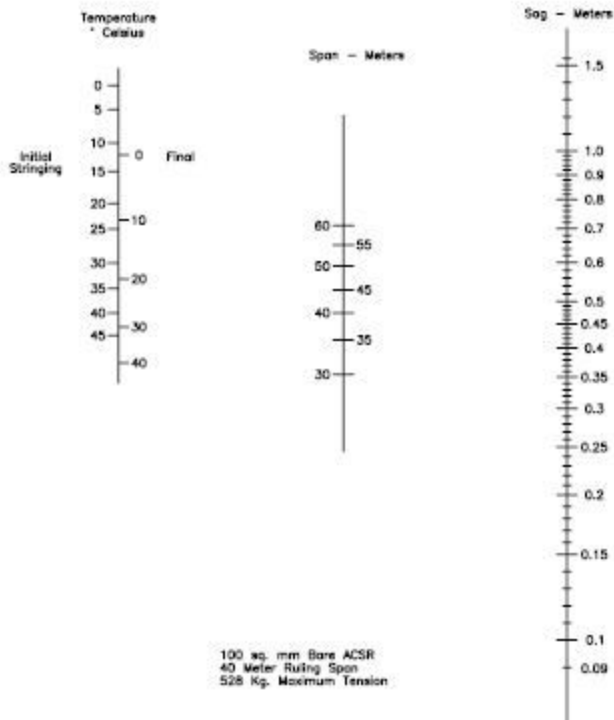

POLE LENGTH (m.)	DEPTH OF BURIAL (m.)	FOUNDATION LENGTH (m.)	SOIL CLASS - Kg/Sq. mm.						
			0.5	0.75	1.0	2.0	3.0	4.0	5.0
			FOUNDATION DIAMETER - mm.						
9	1.5	1.5	1050	860	750	530	430	N/R	N/R
11	1.8	1.8	1080	880	780	540	440	N/R	N/R

N/R = NOT REQUIRED

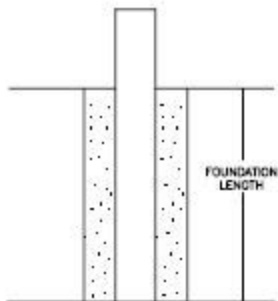
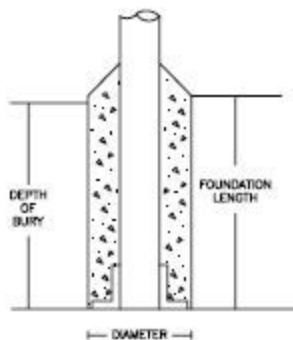

FOUNDATION FOR STEEL TUBULAR  
AND CONCRETE POLES

#### FOUNDATION

CONCRETE TO BE USED FOR FOUNDATIONS:

- 1 PART CEMENT
- 2 PART SAND
- 3 PART AGGREGATE

BY VOLUME

WATER - CEMENT RATIO:  
32 LITERS - 50Kg. APPROX.

Note: In case of non-galvanized steel pole the foundation above ground level shall be 0.4 m more than that is shown in the drawing.



PSC POLE

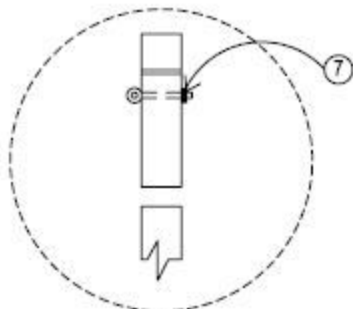

TYPE A

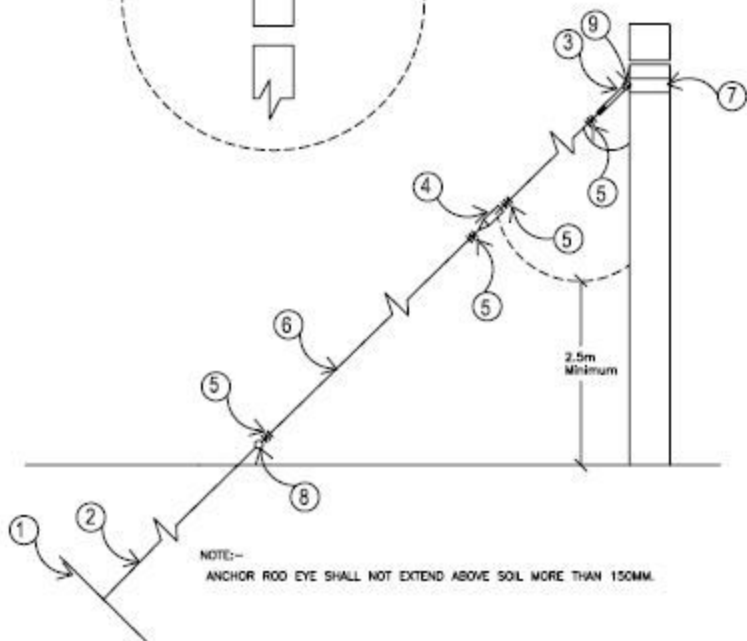

NOTE:-

ANCHOR ROD EYE SHALL NOT EXTEND ABOVE SOIL MORE THAN 150MM.

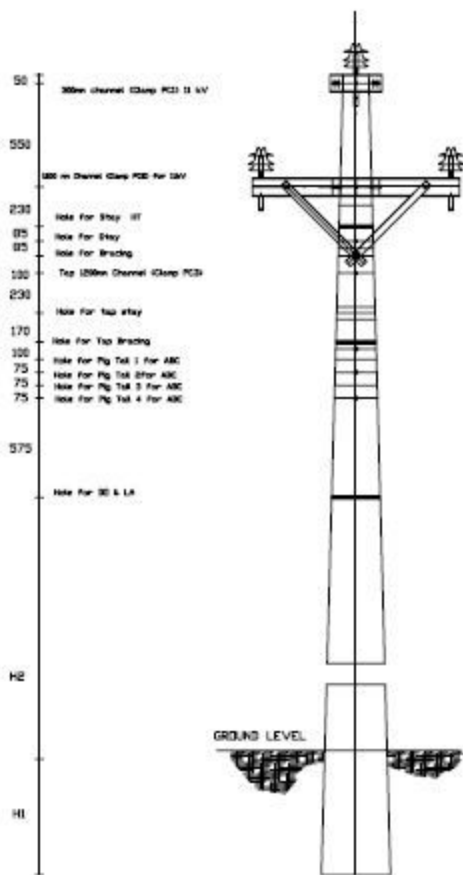

DESCRIPTION	POLE HEIGHT 10-M	POLE HEIGHT 11-M
HEIGHT 10 IN MM	1700	1800
HEIGHT 11 IN MM	3000	3300
POLE WIDTH AT TOP 10' IN MM	180	180
POLE WIDTH AT BOTTOM 10' IN MM	330	430
POLE WIDTH 11'	180	180

ALL DIMENSIONS ARE IN MM

Drawing  
CS11-PSCP-04

11kV, 10/11 m PSC Pole  
Single Arm Structure

NEPAL ELECTRICITY AUTHORITY  
Technical Services / Commercial Department  
Distribution and Consumer Services

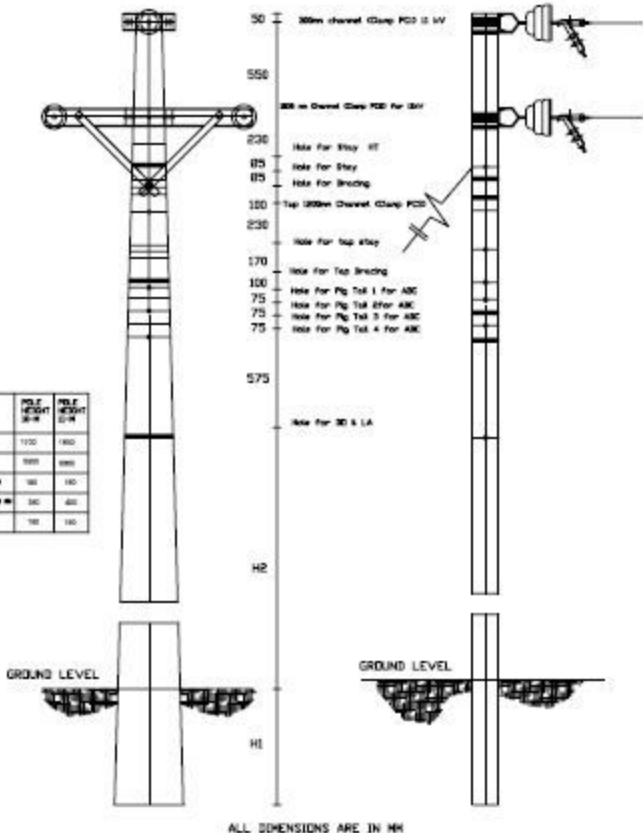

Drawing  
CS11-PSCP-07

11 kV, 10/11 m PSC Pole  
Dead End Structure

NEPAL ELECTRICITY AUTHORITY  
Technical Services / Commercial Department  
Distribution and Consumer Services

TOP VIEW

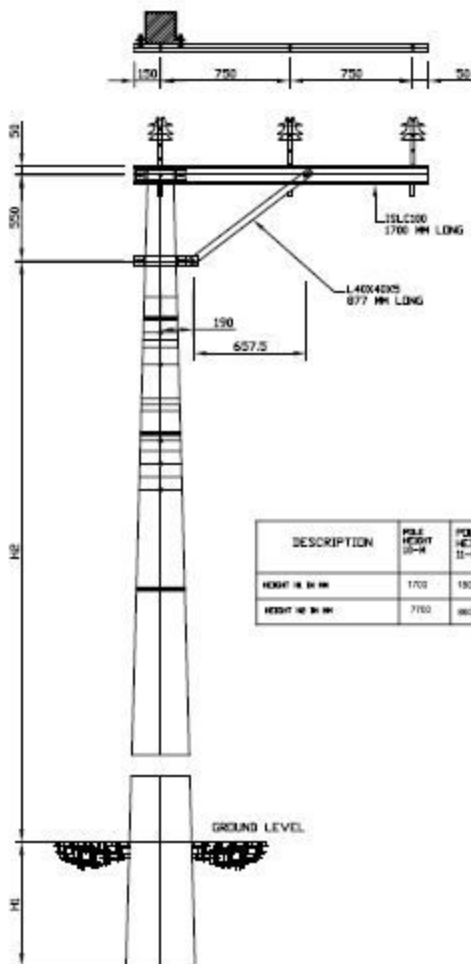

Drawing  
CS11-PSCP-09

11 kV, 10/11 m PSC Pole  
Offset Pole Structure

NEPAL ELECTRICITY AUTHORITY  
Technical Services / Commercial Department  
Distribution and Consumer Services

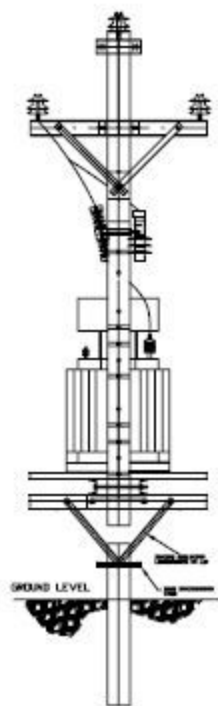

SIDE VIEW

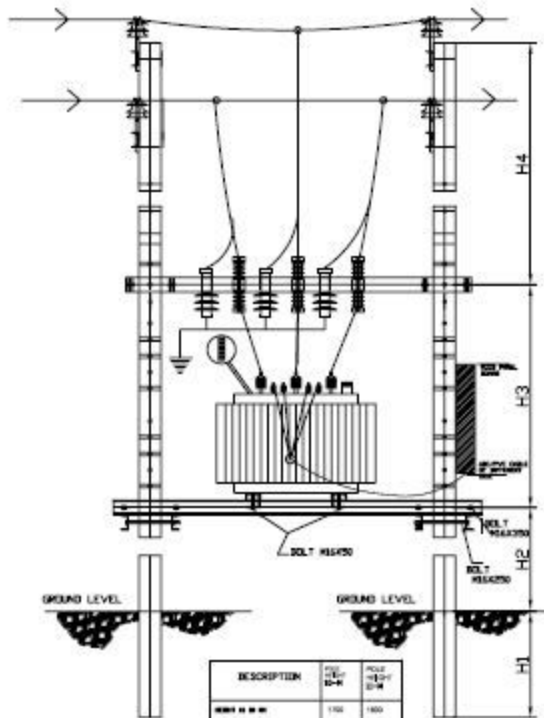

FRONT VIEW

DESCRIPTION	POLE TYPE SD-N	POLE HEIGHT D/M
HEIGHT 10 M	1702	1800
HEIGHT 10 M	1650	2000
HEIGHT 10 M	2400	2400
HEIGHT 10 M	2400	2600

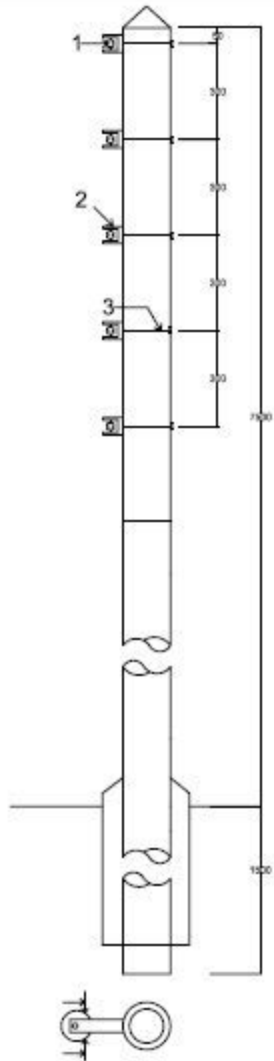

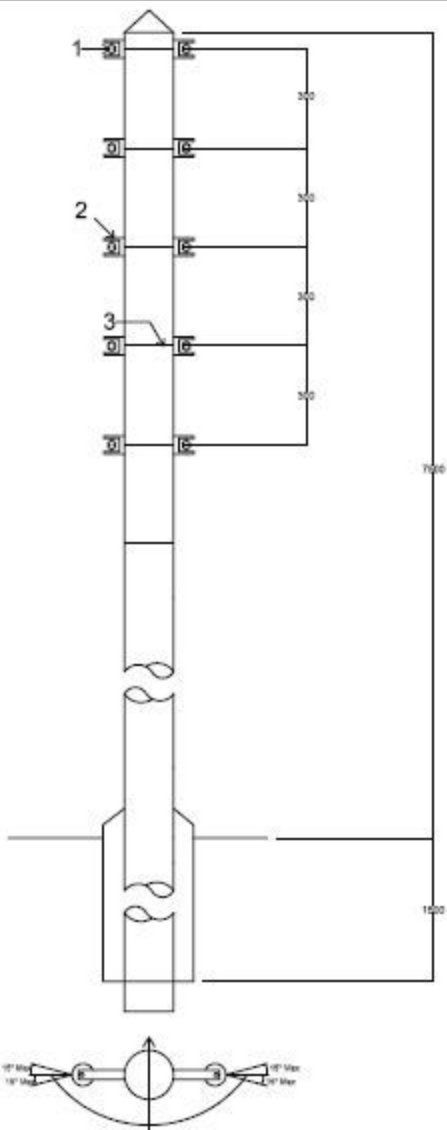

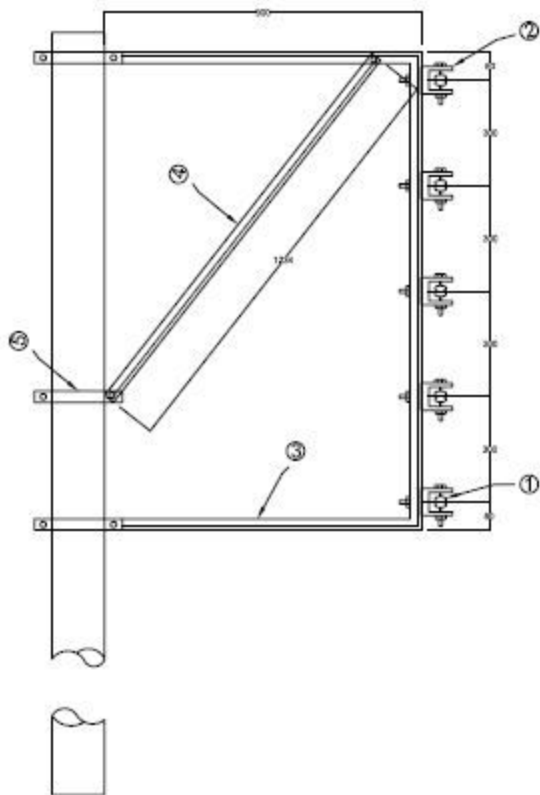

Drawing  
CSLV-0009

LV OVERHEAD POLE WITH O-BRACKET

NEPAL ELECTRICITY AUTHORITY  
 Technical Services/ Commercial Department  
 Distribution and Consumer Services



**Section - VIII**  
**Bill of Quantities**

## **Notes for Unit Rate Contracts:**

### **Objectives**

The objectives of the Bill of Quantities are

- (a) To provide sufficient information on the quantities of Works to be performed to enable Bids to be prepared efficiently and accurately; and
- (b) When a Contract has been entered into, to provide a priced Bill of Quantities for use in the periodic valuation of Works executed.

In order to attain these objectives, Works should be itemized in the Bill of Quantities in sufficient detail to distinguish between the different classes of Works, or between Works of the same nature carried out in different locations or in other circumstances which may give rise to different considerations of cost. Consistent with these requirements, the layout and content of the Bill of Quantities should be as simple and brief as possible.

### **Content**

The Bill of Quantities should be divided generally into the following sections:

- (a) Preamble;
- (b) Work Items (grouped into parts);
- (c) Day works Schedule;
- (d) Provisional Sums; and
- (d) Summary.

### **Preamble**

The Preamble should indicate the inclusiveness of the unit prices, and should state the methods of measurement which have been adopted in the preparation of the Bill of Quantities and which are to be used for the measurement of any part of the works.

### **Work Items**

The items in the Bill of Quantities should be grouped into sections to distinguish between those parts of the Works which by nature, location, access, timing, or any other special characteristics may give rise to different methods of construction, or phasing of the Works, or considerations of cost. General items common to all parts of the works may be grouped as a separate section in the Bill of Quantities.

### **Day work Schedule**

A Day work Schedule should be included only if the probability of unforeseen work, outside the items included in the Bill of Quantities, is high. To facilitate checking by the Employer of the realism of rates quoted by the Bidders, the Day work Schedule should normally comprise the following:

- (a) A list of the various classes of labour, materials, and Constructional Plant for which basic day work rates or prices are to be inserted by the Bidder, together with a statement of the conditions under which the Contractor will be paid for work executed on a day work basis.
- (b) Nominal quantities for each item of Day work, to be priced by each Bidder at Day work rates as bid. The rate to be entered by the Bidder against each basic Day work item should include the Contractor's profit, overheads, supervision, and other charges.

**Provisional Sums**

A general provision for physical contingencies (quantity overruns) may be made by including a provisional sum in the Summary Bill of Quantities. Similarly, a contingency allowance for possible price increases should be provided as a provisional sum in the Summary Bill of Quantities. The inclusion of such provisional sums often facilitates budgetary approval by avoiding the need to request periodic supplementary approvals as the future need arises. Where such provisional sums or contingency allowances are used, the Contract Data should state the manner in which they will be used, and under whose authority (usually the Project Manager's).

**Summary**

The Summary should contain a tabulation of the separate parts of the Bill of Quantities carried forward, with provisional sums for Day work, for physical (quantity) contingencies, and for price contingencies (upward price adjustment) where applicable.

**These Notes for Preparing Specifications are intended only as information for the Employer or the person drafting the Bidding documents. They should not be included in the final documents.**

# Preamble of Bill of Quantities

## A. General

1. The Bill of Quantities shall be read in conjunction with the Instructions to Bidders, General and Special Conditions of Contract, Technical Specifications, and Drawings.
2. The quantities given in the Bill of Quantities are estimated and provisional, and are given to provide a common basis for bidding. The basis of payment will be the actual quantities of work ordered and carried out, as measured by the Contractor and verified by the Project Manager and valued at the rates and prices bid in the priced Bill of Quantities, where applicable, and otherwise at such rates and prices as the Project Manager may fix within the terms of the Contract.
3. For any item for which measurement is based on records made before or during construction the records shall be prepared and agreed between the Engineer and the Contractor. Should the Contractor carry out such work without the prior agreement of the Engineer, the Engineer may request the Contractor to carry out investigations to confirm the extent of the work and the quantity of work certified for payment shall be solely at the Engineer's discretion. The cost of any such investigation shall be borne by the Contractor.
4. The rates and prices bid in the priced Bill of Quantities shall, except as otherwise provided under the Contract, include all construction equipment, labour, supervision, materials, erection, maintenance, insurance, profit, taxes, and duties, together with all general risks, liabilities, and obligations set out or implied in the Contract.
5. A rate or price shall be entered against each item in the priced Bill of Quantities, whether quantities are stated or not. The cost of items against which the Contractor has failed to enter a rate or price shall be deemed to be covered by other rates and prices entered in the Bill of Quantities.
6. The whole cost of complying with the provisions of the Contract shall be included in the Items provided in the priced Bill of Quantities, and where no Items are provided, the cost shall be deemed to be distributed among the rates and prices entered for the related Items of Work.
7. General directions and descriptions of work and materials are not necessarily repeated nor summarized in the Bill of Quantities. References to the relevant sections of the Contract documentation shall be made before entering prices against each item in the priced Bill of Quantities. The Specification Clause references where given in the item description of the Bills of Quantities are for the convenience of bidders and generally refer to the principal relevant-specification clause but do not necessarily represent the whole of the specification requirements for the work required within the item. The presence of a Specification clause reference shall not in any way reduce the Bidders obligation to complete work in accordance with all the requirements of the Specification.
8. Provisional Sums included and so designated in the Bill of Quantities shall be expended in whole or in part at the direction and discretion of the Project Manager in accordance with the Conditions of Contract.
9. The method of measurement of completed work for payment shall be in accordance with the Specifications.
10. The abbreviations and symbols used in this Bill of Quantities are:  
***[Insert as applicable]***

## **B. Day work Schedule**

### **a) General**

1. Work shall not be executed on a day work basis except by written order of the Project Manager. Bidders shall enter basic rates for day work items in the Schedules. These rates shall apply to any quantity of day work ordered by the Project Manager. Nominal quantities have been indicated against each item of day work, and the extended total for day work shall, be carried forward as a Provisional Sum to the Summary Total Bid Amount. Unless otherwise adjusted, payments for day work shall be subject to price adjustment in accordance with the provisions in the Conditions of Contract.

### **b) Day work Labour**

1. In calculating payments due to the Contractor for the execution of day works, the hours for labour will be reckoned from the time of arrival of the labour at the job site to execute the particular item of day work to the time of departure from the job site, but excluding meal breaks and rest periods. Only the time of classes of labour directly doing work ordered by the Project Manager and are competent to perform such work will be measured. The time of gangers (charge hands) actually doing work with the gangs will also be measured but not the time of foremen or other supervisory personnel.
2. The Contractor shall be entitled to payment in respect of the total time that labour is employed on day work, calculated at the basis rates entered by it in the " SCHEDULE OF DAY WORK RATES: 1. LABOUR ". The rates for labour shall be deemed to cover all costs to the Contractor including (but not limited to) i) the amount of wages paid to such labour, transportation time, overtime, subsistence allowances, ii) any sums paid to or on behalf of such labour for social benefits in accordance with Nepal law, iii) Contractor's profit, overheads, superintendence, liabilities and insurance and iv) charges incidental to the foregoing.

### **c) Day work Equipment**

1. The Contractor shall be entitled to payments in respect of Constructional Plant already on site and employed on day work at the basis rental rates entered by him in the "SCHEDULE OF DAY WORK RATES:2 EQUIPMENT ". The said rates shall be deemed to include due and complete allowance for depreciation, interest, indemnity and insurance, repairs, maintenance, supplies, fuel, lubricant, and other consumables and all overhead, profit and administrative costs related to the use of such equipment. The cost of drivers, operators and assistants also shall be included in the rate of the equipment and no separately payment shall be made for it.
2. In calculating the payment due to the Contractor for Constructional Plant employed on day work, only the actual number of working hours will be eligible for payment, except that where applicable and agreed with the Project Manager, the travelling time from the part of the Site where the Construction Plant was located when ordered by the Project Manager to be employed on day work and the time for return journey there to shall be included for payment.

### **d) Day work Materials**

1. The Contractor shall be entitled to payment in respect of materials used for day work (except for materials for which the cost is included in the percentage addition to labour costs as detailed heretofore), at the rates entered by him in the "SCHEDULE OF DAY WORK RATES: 3 MATERIALS" and shall be deemed to include overhead charges and profit as follows;
  - (i) the rates for materials shall be calculated on the basis of the invoiced price, freight, insurance, handling expenses, damage, losses, etc. and shall provide for delivery to store for stockpiling at the Site.
  - (ii) the cost of hauling materials for use on work ordered to be carried out as day work, from the store or stockpile on the Site to the place where it is to be used also shall be include in the same rate.

## **Provisional Sums**

A general provision for physical contingencies (quantity overruns) may be made by including a provisional sum in the Summary Bill of Quantities. Similarly, a contingency allowance for possible price increases should be provided as a provisional sum in the Summary Bill of Quantities. The inclusion of such provisional sums often facilitates budgetary approval by avoiding the need to request periodic

supplementary approvals as the future need arises. Where such provisional sums or contingency allowances are used, the SCC should state the manner in which they will be used, and under whose authority (usually the Project Manager's).

The estimated cost of specialized work to be carried out, or of special goods to be supplied, by other contractors should be indicated in the relevant part of the Bill of Quantities as a particular provisional sum with an appropriate brief description. A separate procurement procedure is normally carried out by the Employer to select such specialized contractors. To provide an element of competition among the Bidders in respect of any facilities, amenities, attendance, etc., to be provided by the successful Bidder as prime Contractor for the use and convenience of the specialist contractors, each related provisional sum should be followed by an item in the Bill of Quantities inviting the Bidder to quote a sum for such amenities, facilities, attendance, etc.

# Bill of Quantities

1 Provisional Sum						
Procument Item Details						
Sl. No.	Item Description	Unit	Quantity	Unit Rate (NPR)	Amount (NPR)	
1			0.0	0.0	0.00	
2 Construction work						
Procument Item Details						
Sl. No.	Item Description	Unit	Quantity	Bidder's Rate (NPR)	Bidder's Rate (in words)	Total Amount (NPR)
1	Erection of 9 Mtr PSC Pole, fitting require all component	Nos	30.00			
2	Erection of 8/9 Mtr STP, fitting require all component	Nos	60.00			
3	Stringing of ABC cable 50 sq mm	Km	2.20			
4	Stringing of ABC cable 25 sq mm	Km	1.00			
5	Installation of Stay set	sets	20.00			
6	Consumer service cable connection	Nos	100.00			
Total of Procument Items						
<b>Total Item Price</b>						
<b>VAT</b>						
<b>Grand Total</b>						

**Section - IV**  
**General Conditions of Contract**



## Section VII. General Conditions of Contract (GCC)

<b>1. General Provisions</b>	
<b>1.1 Definitions</b>	In the Contract as defined below, the words and expressions defined shall have the following meanings assigned to them, except where the context requires otherwise:
<b>The Contract</b>	<p>1.1.1 <b>“Contract”</b> means the Agreement signed between the Employer and the contractor and the other documents listed in the Special Conditions of Contract (SCC).</p> <p>1.1.2 <b>“Specification”</b> means the document as listed in the SCC, and any variation to such document.</p> <p>1.1.3 <b>“Drawings”</b> means the Employer’s drawings of the Works as listed in the SCC, and any variation to such drawings.</p> <p>1.1.4 <b>“Bill of Quantities”</b> means the priced and completed bill of quantities forming part of the Tender.</p> <p>1.1.5 <b>“Bid or Quotation”</b> means the contractor’s priced offer to the Employer for the execution and completion of the Works and the remedying of any defects therein in accordance with the provisions of the Contract, as accepted by the Letter of Acceptance.</p> <p>1.1.6 <b>“Letter of Acceptance”</b> means the formal acceptance by the Employer of the <b>bid</b> or Tender.</p>
<b>Persons</b>	<p>1.1.7 <b>“Employer”</b> means the person named in the Agreement and the legal successors in title to this person, but not (except with the consent of the contractor) any assignee.</p> <p>1.1.8 <b>“Contractor”</b> means the person named in the Agreement and the legal successors in title to this person, but not (except with the consent of the Employer) any assignee.</p> <p>1.1.9 <b>“Party”</b> means either Employer or the contractor.</p>
<b>Date, Times and Periods</b>	<p>1.1.10 <b>“Commencement Date”</b> means the date stated in the SCC after the date the Agreement comes into effect or any other date agreed between the Parties.</p> <p>1.1.11 <b>“Day”</b> means a calendar day.</p>

	<p>1.1.12 "<b>Time for Completion</b>" means the time for completing the Works as stated in the SCC (or as extended under Sub-Clause 6.3), calculated from the Commencement Date.</p>
<b>Money and Payments</b>	<p>1.1.13 "<b>Cost</b>" means all expenditure properly incurred (or to be incurred) by the contractor, whether on or off the Site, including overheads and similar charges, but does not include profit.</p> <p>1.1.14 "<b>Contract Price</b>" means the sum stated in the Letter of Acceptance as payable to the contractor and adjusted with any Variation Orders and Other Adjustments upon completion of the works and the remedying of any defects therein in accordance with the provisions of the Contract.</p> <p>1.1.15 "<b>Retention Money</b>" means the aggregate of all monies retained by the Employer pursuant to Sub-Clause 10.3</p>
<b>Other Definitions</b>	<p>1.1.16 "<b>Contractor's Equipment</b>" means all apparatus, machinery, vehicles, facilities and other things required for the execution of the Works but does not include Materials or Plant.</p> <p>1.1.17 "<b>Country</b>" means Nepal.</p> <p>1.1.18 "<b>Employer's Liabilities</b>" means those matters listed in Sub-Clause 5.1.</p> <p>1.1.19 "<b>Materials</b>" means things of all kinds (other than Plant) intended to form or forming part of the permanent work.</p> <p>1.1.20 "<b>Plant</b>" means the machinery and apparatus intended to form or forming part of the Permanent Works.</p> <p>1.1.21 "<b>Site</b>" means the places provided by the Employer where the Works are to be executed, and any other places specified in the Contract as forming part of the Site.</p> <p>1.1.22 "<b>Variation</b>" means any change which is a result of unforeseen circumstances that arise as a result of instruction by the Employer/ Engineer under Sub-Clause 9.1.</p> <p>1.1.23 "<b>Works</b>" means all the work and design (if any) to be performed by the contractor including temporary work and any Variation.</p> <p>1.1.24 "<b>Permanent Works</b>" means the permanent works to be executed (Including Plant) in accordance with the Contract.</p> <p>1.1.25 "<b>Temporary Works</b>" means all temporary works of every kind (other than contractor's Equipment) required in or about the execution and completion of the Works and the remedying of any defects therein.</p>
<b>1.2 Interpretation</b>	<p>Words importing persons or parties shall include firms and organisations. Words importing singular or one gender shall include plural or the other gender where the context requires.</p>
<b>1.3 Priority of Documents</b>	<p>The documents forming the Contract shall to be taken as mutually explanatory of one another. If an ambiguity or discrepancy is found in the documents, the Employer shall issue any necessary instructions to the contractor, and the priority of the documents shall be in accordance with the order as <b>listed in the SCC</b>.</p>
<b>1.4 Law</b>	<p>The law of the Contract is stated in the Law of Nepal.</p>

<b>1.5 Communications</b>	<p>Where provision is made for the giving or issue of any notice, instruction, or other communication by any person, unless otherwise specified such communication shall be written in the language stated in the SCC as shall not be unreasonably withheld or delayed.</p> <p>If a notice given pursuant to Sub Clause 1.5 fails to be delivered due to failure to trace the address of the party then the notice shall be published as public notice in a National daily newspaper and when the notice is so published then the notice shall be considered to be delivered to the concerned party.</p>
<b>1.6 Statutory Obligations</b>	<p>The contractor shall comply with the laws of Nepal where activities are performed. The contractor shall give all notices and pay all fees and other charges in respect of the Works.</p>
<b>2. The Employer</b>	
<b>2.1 Provision of Site</b>	<p>The Employer shall provide the Site and right of access thereto at the times stated in the SCC.</p>
<b>2.2 Permits and Licenses</b>	<p>The Employer shall, if requested by the contractor, assist him in applying for permits, licences or approvals which are required for the Works.</p>
<b>2.3 Employer's Instructions</b>	<p>The contractor shall comply with all instructions given by the Employer in respect of the Works including the suspension of all or part of the Works.</p>
<b>2.4 Approvals</b>	<p>No approval or consent or absence of comment by the Employer or the Employer's representative shall affect the contractor's obligations.</p>
<b>3. Employer's Representatives</b>	
<b>3.1 Authorised Person</b>	<p>One of the Employer's personnel shall have authority to act for him. This authorised person shall be as stated in the SCC, or as otherwise notified by the Employer to the contractor.</p>
<b>3.2 Employer's Representative</b>	<p>The Employer may also appoint a firm or individual to carry out certain duties. The appointee may be named in the SCC, or notified by the Employer to the contractor from time to time. The Employer shall notify the contractor of the delegated duties and authority of this Employer's representative.</p>
<b>4. The Contractor</b>	
<b>4.1 General Obligations</b>	<p>The contractor shall carry out the Works properly and in accordance with the Contract. The contractor shall provide all supervision, labour, Materials, Plant and contractor's Equipment which may be required. All Materials and Plant on Site shall be deemed to be the property of the Employer.</p> <p>During continuance of the of the contract, the contractor and his sub-contractors shall abide at all times by all labour laws, including child labour related enactments, and rules made there under.</p> <p>A child who has not attained the age of fourteen years shall not be employed in any work as a labourer.</p>

<b>4.2 Contractor's Representative</b>	The contractor shall submit to the Employer for consent the name and particulars of the person authorised to receive instructions on behalf of the contractor.
<b>4.3 Subcontracting</b>	The contractor shall not subcontract the Works.
<b>4.4 Performance Security</b>	As <b>stated in the SCC</b> , the Contractor shall deliver to the Employer no later than the date specified in the Letter of Acceptance.
<b>5. Employer's Liabilities</b>	
<b>5.1 Employer's Liabilities</b>	<p>In this Contract, Employer's Liabilities mean:</p> <ul style="list-style-type: none"> <li>a. war, hostilities (whether war be declared or not), invasion, act of foreign enemies, within the Country,</li> <li>b. rebellion, terrorism, revolution, insurrection, military or usurped power, or civil war, within the Country,</li> <li>c. riot, commotion or disorder by persons other than the contractor's personnel and other employees, affecting the Site and/or the Works.</li> <li>d. use or occupation by the Employer of any part of the Works, except as may be specified in the Contract,</li> <li>e. design of any part of the Works by the Employer's personnel or by others for whom the Employer is responsible,</li> <li>f. any operation of the forces of nature affecting the Site and/or the Works, which was unforeseeable or against which an experienced contractor could not reasonably have been expected to take precautions</li> <li>g. a suspension under Sub-Clause 2.3 unless it is attributable to the contractor's failure,</li> <li>h. any failure of the Employer,</li> <li>i. physical obstructions or physical conditions, other than climatic conditions, encountered on the Site during the performance of the Works, which obstructions or conditions were not reasonably foreseeable by an experienced contractor and which the contractor immediately notified to the Employer,</li> <li>j. any delay or disruption caused by any Variation,</li> <li>k. any change to the law of the Contract after the date of the contractor's offer as stated in the Agreement,</li> <li>l. losses arising out of the Employer's right to have the permanent work executed on, over, under, in or through any land, and to occupy this land for the permanent work, and</li> <li>m. damage which is an unavoidable result of the contractor's obligations to execute the Works and to remedy any defects.</li> </ul>
<b>6. Time for Completion</b>	
<b>6.1 Execution of the Works</b>	The contractor shall commence the Works on the Commencement Date and shall proceed expeditiously and without delay and shall complete the Works within the Time for Completion.
<b>6.2 Programme</b>	The contractor shall submit to the Employer a programme for the Works within the time stated in the SCC

<b>6.3 Extension of Time</b>	<p>The contractor shall be entitled to an extension to the Time for Completion if he is or shall be delayed by any of the Employer's Liabilities.</p> <p>The contractor shall submit an application to the Employer for extension of time, stating the causes for delay, 21 days before the expiry of the Contract completion date.</p> <p>On receipt of an application from the contractor, within 21 days , the Employer shall consider all supporting details provided by the contractor and shall decide extend the Time for Completion as appropriate.</p>
<b>6.4 Liquidated Damages for Delay</b>	<p>If the contractor fails to complete the Works within the Time for Completion, the contractor's liability to the Employer for such failure shall be to pay the amount stated in the SCC for each day for which he fails to complete the Works.</p>
<b>7. Taking-Over</b>	
<b>7.1 Completion</b>	<p>The contractor may notify the Employer when he considers that the Works are complete.</p> <p>In addition to the other provisions, before acceptance of the completed works, Employer shall verify and assure that such works are within the set objective, quality and appropriate to operate and use.</p>
<b>7.2 Taking-Over Notice</b>	<p>The Employer shall notify the Contractor when he considers that the Contractor has completed the Works stating the date accordingly. Alternatively, the Employer may notify the Contractor that the Works, although not fully complete, are ready for taking over, stating the date accordingly.</p> <p>The Employer shall take over the Works upon the issue of this notice. The Contractor shall promptly complete any outstanding work and, subject to Clause 8, clear the Site.</p>
<b>8. Remedying Defects</b>	
<b>8.1 Remedying Defects</b>	<p>The Employer may at any time prior to the expiry of the period stated in the SCC, notify the Contractor of any defects or outstanding work. The Contractor shall remedy at no cost to the Employer any defects due to the Contractor's design, materials, plant or workmanship not being in accordance with the Contract.</p> <p>Failure to remedy any defects or complete outstanding work within a reasonable time of the Employer's notice shall entitle the Employer to carry out all necessary work at the Contractor's cost.</p>
<b>8.2 Uncovering and Testing</b>	<p>The Employer may give instruction as to the uncovering and/or testing of any work. Unless as a result of any uncovering and/or testing it is established that the contractor's design, materials, plant or workmanship are not in accordance with the Contract, the Contractor shall be paid for such uncovering and/or testing as a Variation in accordance with Sub-Clause 9.2.</p>
<b>9. Variations and Claims</b>	
<b>9.1 Right to Vary</b>	<p>The Employer may instruct Variations.</p>

<b>9.2 Valuation of Variations</b>	Variations shall be valued as follows: a. where appropriate, at rates in the Contract, or b. in the absence of appropriate rates, the rates in the Contract shall be used as the basis for valuation or c. at appropriate new rates, as may be agreed or which the Employer considers appropriate.
<b>9.4 Right to Claim</b>	If the contractor incurs cost as a result of any of the Employer's Liabilities, the contractor shall be entitled to the amount of such cost. If as a result of any of the Employer's Liabilities, it is necessary to change the Works, this shall be dealt with as a Variation.
<b>9.5 Variation and Claim Procedure</b>	The contractor shall submit the Employer an itemised make-up of the value of Variations and claims within 7 days of the instruction or of the event giving rise to the claim. The Employer shall check and if possible agree the value. In the absence of agreement, the Employer shall determine the value.
<b>10. Contract Price and Payment</b>	
<b>10.1 Valuation of the Works</b>	The Contract Bill of Quantities and the approved Variation quantities shall be used to calculate the valuation of the works completed .The Contractor shall be paid for the quantity of work done at the rate in the Bill of Quantities or rate agreed pursuant to clause 9.2 for varied works.
<b>10.2 Payments Certificates</b>	The Contractor shall submit to the Employer monthly statements of the estimated value of the works completed less the cumulative amount certified previously. The Employer shall check the Contractor's monthly statement and certify the amount to be paid to the Contractor
<b>10.3 Payments</b>	The Employer shall pay to the contractor the amount certified less retention at the rate stated in the SCC within 30 days of the date of each certificate.
<b>10.4 Payment of Retention</b>	One half of the retention shall be repaid by the Employer to the contractor within 30 days upon expiry of Defects Liability Period and the Employer has certified that the notified defects have been corrected.  The remainder of the retention shall be paid by the Employer to the contractor within 7 days after submission of evidence document from the concerned Internal Revenue Office that the contractor has submitted his Income Returns
<b>10.5 Advance Payment</b>	10.5.1 The Employer shall make advance payment to the Contractor of the amounts stated in the SCC in two equal installments by the date stated in the SCC, against provision by the Contractor of an unconditional bank guarantee from Commercial Bank or Financial Institution eligible to issue Bank Guarantee as per prevailing Law in Nepal in a form acceptable to the Employer in amounts equal to the advance payment. The guarantee shall remain effective until the advance payment has been repaid, but the amount of the guarantee shall be progressively reduced by the amounts repaid by the Contractor. Interest shall not be charged on the advance payment.

	<p>10.5.2 The Contractor is to use the advance payment only to pay for Equipment, Plant, Materials, and mobilization expenses required specifically for execution of the Contract. The Contractor shall demonstrate that advance payment has been used in this way by supplying copies of invoices or other documents to the Project Manager.</p> <p>10.5.3 The advance payment shall be repaid by deducting proportionate amounts, as stated in SCC, from payments otherwise due Contractor, following the schedule of completed percentages of the Works on a payment basis. No account shall be taken of the advance payment or its repayment in assessing valuations of work done, Variations, price adjustments, Compensation Events, Bonuses, or Liquidated Damages.</p>
<p><b>10.6 Local Taxation &amp; Value Added Tax</b></p>	<p>a. The prices quoted by the Contractor shall include all taxes that may be levied in accordance to the laws and regulations in being in Nepal.</p> <p>b. The Contractor shall pay VAT in the concerned VAT office within time frame specified in VAT regulation.</p>
<p><b>11. Termination of Contract and Payment</b></p>	<p>11.1 The Employer may terminate the Contract at any time if the contractor;</p> <ul style="list-style-type: none"> <li>a. does not commence the work as per the Contract,</li> <li>b. abandons the work without completing,</li> <li>c. fails to achieve progress as per the Contract.</li> </ul> <p>11.2 The Employer or the Contractor may terminate the Contract if the other party causes a fundamental breach of the Contract.</p> <p>11.3 Fundamental breaches of Contract shall include, but shall not be limited to, the following :</p> <ul style="list-style-type: none"> <li>(a) The Contractor uses the advance payment for matters other than the contractual obligations,</li> <li>(b) the Contractor stops work for 30 days when no stoppage of work is shown on the current Program and the stoppage has not been authorized by the Project Manager;</li> <li>(c) the Project Manager instructs the Contractor to delay the progress of the Works, and the instruction is not withdrawn within 30 days;</li> <li>(d) the Employer or the Contractor is made bankrupt or goes into liquidation other than for a reconstruction or amalgamation.</li> <li>(e) a payment certified by the Project Manager is not paid by the Employer to the Contractor within 90 days of the date of the Project Manager’s certificate;</li> <li>(f) the Project Manager gives Notice that failure to correct a particular Defect is a fundamental breach of Contract and the Contractor fails to correct it within a reasonable period of time determined by the Project Manager;</li> <li>(g) The Contractor fails to update the Program as per the contract and demonstrate acceleration of the works within a reasonable period of time determined by the Project Manager;</li> <li>(h) the Contractor does not maintain a Security, which is required;</li> <li>(i) the Contractor has delayed the completion of the Works by the number of</li> </ul>

	<p>days for which the maximum amount of liquidated damages can be paid, as defined in the SCC 6.4 ; and</p> <p>(j) If the Contractor, in the judgment of the Employer has engaged in corrupt or fraudulent practices in competing for or in executing the Contract.</p> <p>11.5 Notwithstanding the above, the Employer may terminate the Contract for convenience.</p> <p>11.6 If the Contract is terminated, the Contractor shall stop work immediately, make the Site safe and secure, and leave the Site as soon as reasonably possible.</p>
	<p>11.7 If the Contract is terminated because of a fundamental breach of Contract by the Contractor, the Project Manager shall issue a certificate for the value of the work done and Materials ordered less advance payments received up to the date of the issue of the certificate. Additional Liquidated Damages shall not apply. If the total amount due to the Employer exceeds any payment due to the Contractor, the difference shall be a debt payable to the Employer.</p> <p>11.8 If the Contract is terminated for the Employer's convenience or because of a fundamental breach of Contract by the Employer, the Project Manager shall issue a certificate for the value of the work done, Materials ordered, the reasonable cost of removal of Equipment, repatriation of the Contractor's personnel employed solely on the Works, and the Contractor's costs of protecting and securing the Works, and less advance payments received up to the date of the certificate.</p> <p>11.9 If the Contract is terminated because of fundamental breach of Contract or for any other fault by the Contractor, the performance security shall be forfeited by the Employer.</p> <p>In such case, amount to complete the remaining works as per the Contract shall be recovered from the Contractor as Government dues.</p>
<p><b>12. Risk and Responsibility</b></p>	
<p><b>12.1 Contractor's Care of the Works</b></p>	<p>The contractor shall take full responsibility for the care of the Works from the Commencement Date until the date of the Employer's notice under Sub-Clause 7.2. Responsibility shall then pass to the Employer. If any loss or damage occurs to the Works during the above period, the contractor shall rectify such loss or damage so that the Works conform to the Contract.</p>
<p><b>12.2 Force Majeure</b></p>	<p>If a Party is or shall be prevented from performing any of its obligations by Force Majeure, the Party affected shall notify the other Party immediately. If necessary, the contractor shall suspend the execution of the Works and, to the extent agreed with the Employer, demobilise the contractor's Equipment.</p> <p>If the event continues for a period of 90 days, either Party may then give notice of termination which shall take effect 30 days after the giving of the notice.</p> <p>After termination, the contractor shall be entitled to payment of the unpaid balance of the value of the Works executed and of the Materials and Plant reasonably delivered to the Site, adjusted by the following:</p> <p>a. any sums to which the contractor is entitled under Sub-Clause 9.4,</p>



	<p>b. the Cost of his suspension and demobilisation,  c. any sums to which the Employer is entitled.</p> <p>The net balance due shall be paid or repaid within 30 days of the notice of termination.</p>
<b>13. Resolution of Disputes</b>	
<b>13.2 Amicable Settlement</b>	<p>The Employer and the Contractor shall attempt to settle amicably by direct negotiation any disagreement or dispute arising between them under or in connection with the Contract.</p>
<b>14. Conduct of Bidders</b>	<p>14.1 The Bidder shall be responsible to fulfill his obligations as per the requirement of the Contract Agreement, Bidding documents, GoN's Procurement Act and Regulations.</p> <p>14.2 The Bidder shall not carry out or cause to carry out the following acts with an intention to influence the implementation of the procurement process or the procurement agreement :</p> <ul style="list-style-type: none"> <li>a) give or propose improper inducement directly or indirectly,</li> <li>b) distortion or misrepresentation of facts</li> <li>c) engaging or being involved in corrupt or fraudulent practice</li> <li>d) interference in participation of other prospective bidders.</li> <li>e) coercion or threatening directly or indirectly to cause harm to the person or the property of any person to be involved in the procurement proceedings,</li> <li>f) collusive practice among bidders before or after submission of bids for distribution of works among bidders or fixing artificial/uncompetitive bid price with an intention to deprive the Employer the benefit of open competitive bid price..</li> <li>g) contacting the Employer with an intention to influence the Employer with regards to the bid or interference of any kind in examination and evaluation of the bids during the period after opening of bids up to the notification of award of contract</li> </ul>
<b>15. Blacklisting Bidder</b>	<p>15.1 Without prejudice to any other right of the Employer under this Contract, GoN, Public Procurement Monitoring Office may blacklist a bidder for his conduct up to three years on the following grounds and seriousness of the act committed by the bidder:</p> <ul style="list-style-type: none"> <li>a) if it is proved that the bidder committed acts pursuant to the Sub - Clause 14.2,</li> <li>b) if it is proved later that the bidder/contractor had committed substantial defect in implementation of the contract or had not substantially fulfilled his obligations under the contract or the completed work is not of the specified quality as per the contract ,</li> <li>c) if convicted by a court of law in a criminal offence which disqualifies the bidder from participating in the contract.</li> <li>d) if it is proved that the contract agreement signed by the bidder was</li> </ul>

	<p>based on false or misrepresentation of bidder's qualification information,</p> <p><b>e) other acts mentioned in the Bidding Data</b></p> <p>15.2 A firm declared blacklisted and ineligible by the GON shall be ineligible to bid for a contract during the period of time determined by the PPMO.</p>
16. Provision of PPA and PPR	If any provision of this document are inconsistent with Public Procurement Act (PPA), 2063 or Public Procurement Regulations (PPR), 2064, the provision of this documents shall be void to the extent of such inconsistency and the provision of PPA and PPR shall prevail.

**Section - V**  
**Special Conditions of Contract**

## Section VIII - Special Conditions of Contract (SCC)

This SCC forms part of the Agreement

[Note: with the exception of the items for which the Purchaser's requirements have been inserted, the Bidder shall complete the following information before submitting his Sealed Quotation.]

1.1.1	Documents forming the Contract listed in the order of priority: 1. The Agreement 2. Special Conditions of Contract 3. General Conditions of Contract 4. The Technical Specifications 5. The Drawings 6. The Bill of Quantities
1.1.12	The indented completion date for the works shall be 5 Months .
1.5	The language of the contract is ENGLISH/NEPALI.
2.1	The Site Possession Date(s) shall be: 2 Weeks
3.1	The Authorised person is : Lila Poudel
3.2	Name and Address of Employer's representative is : Sajiv Ramtel, Malepatan Kaski Gandaki Province
4.4	The Performance Security amount is: : % i) If bid price of the bidder selected for acceptance is up to 15 (fifteen) percent below the approved cost estimate, the performance security amount shall be 5 (five) percent of the bid price. ii) For the bid price of the bidder selected for acceptance is more than 15 (fifteen) percent below of the cost estimate, the performance security amount shall be determined as follows: Performance Security Amount = $[(0.85 \times \text{Cost Estimate} - \text{Bid Price}) \times 0.5] + 5\%$ of Bid Price. The Bid Price and Cost Estimate shall be inclusive of Value Added Tax
6.2	Time for the submission of programme : 15 days.
6.4	Liquidated Damages for Delay is 0.05% of the Contract Price per day up to a maximum of 10% of sum stated in the Agreement.
8.1	Period for notifying defects is 365 days calculated from the date stated in the notice under Sub-Clause 7.2.
10.5.1	The Advance Payments shall NOT be applicable
10.5.3	Deductions from Payment Certificates will commence in the first certificate in which the Value of works executed exceeds 30% of the Contract Price. Deduction will be at the rate of 0% of the respective Monthly Interim Payment Certificate until such time as the advance payment has been repaid; provided that the advance payment shall be completely repaid prior to the end of 80 % of the approved contract price.

**Section - IX**  
**Contract Forms**

## Contract Forms

This Section contains forms which, once completed, will form part of the Contract. The forms for Performance Security and Advance Payment Security, when required, shall only be completed by the successful Bidder after contract award.

# Letter of Acceptance

[on letterhead paper of the Employer]

Date: .....

To: ..... name and address of the Contractor .....

Subject: ..... Notification of Award

This is to notify that your Quotation dated .....date .....for execution of the.....name of the contract and identification number, as given in the SCC ..... for the Contract price of Nepalese Rupees [insert amount in figures and words in Nepalese Rupees], as corrected in accordance with the Instructions to Bidders is hereby accepted in accordance with the Instruction to Bidders.

You are hereby instructed to contact this office to sign the formal contract agreement within 7 days with Performance Security of .....[specify the performance security amount computed as per ITB 22.2 and 25.1] consisting of a Bank Guarantee in the format included in Section IX (Contract Forms) of this Bidding Document.

The Employer shall forfeit the bid security, in case you fail to furnish the Performance Security and to sign the contract within specified period.

Authorized Signature: .....

Name and Title of Signatory: .....

# Contract Agreement

THIS AGREEMENT made the .....day of ..... between..... name of the Employer ..... (hereinafter "the Employer"), of the one part, and .....name of the Contractor .....(hereinafter "the Contractor"), of the other part:

WHEREAS the Employer desires that the Works known as ..... name of the Contract .....should be executed by the Contractor, and has accepted a Quotation by the Contractor for the execution and completion of these Works and the remedying of any defects in the sum of NRs .....[insert amount of contract price in words and figures including taxes] (hereinafter "the Contract Price").

The Employer and the Contractor agree as follows:

1. In this Agreement words and expressions shall have the same meanings as are respectively assigned to them in the Contract documents referred to.
2. The following documents shall be deemed to form and be read and construed as part of this Agreement.
  - (a) the Letter of Acceptance;
  - (b) the Letter of Bid;
  - (c) the Addenda Nos ..... insert addenda numbers if any .....
  - (d) the Special Conditions of Contract;
  - (e) the General Conditions of Contract;
  - (f) Bills of Quantities (BOQ);
  - (g) the Specification;
  - (h) the Drawings;
  - (i) the Activity Schedules; and
  - (j).....[Specify if there are any other document ]
3. In consideration of the payments to be made by the Employer to the Contractor as indicated in this Agreement, the Contractor hereby covenants with the Employer to execute the Works and to remedy defects therein in conformity in all respects with the provisions of the Contract.
4. The Employer hereby covenants to pay the Contractor in consideration of the execution and completion of the Works and the remedying of defects therein, the Contract Price or such other sum as may become payable under the provisions of the Contract at the times and in the manner prescribed by the Contract.

IN WITNESS whereof the parties hereto have caused this Agreement to be executed in accordance with the laws of Nepal on the day, month and year indicated above.

Signed by .....  
for and on behalf the Contractor in the  
presence of

Signed by.....  
for and on behalf of the Employer in the  
presence of

Witness, Name Signature, Address, Date

Witness, Name, Signature, Address, Date



# Performance Security

*Bank's Name, and Address of Issuing Branch or Office*

*(On Letter head of the Commercial bank or any Financial Institution eligible to issue Bank Guarantee as per prevailing Law)*

..... *Bank's Name, and Address of Issuing Branch or Office* .....Beneficiary:  
..... Name and Address of Employer .....  
Date: .....

Performance Guarantee No.:.....

We have been informed that ... .. *[insert name of the Contractor]* (hereinafter called "the Contractor") has been notified by you to sign the Contract No. .... *[insert reference number of the Contract]* for the execution of ..... *[insert name of contract and brief description of Works]* (hereinafter called "the Contract").

Furthermore, we understand that, according to the conditions of the Contract, a performance guarantee is required.

At the request of the Contractor, we..... *[insert name of the Bank]* hereby irrevocably undertake to pay you any sum or sums not exceeding in total an amount of .....*[insert name of the currency and amount in figures\*]* (... .. *insert amount in words*) such sum being payable in Nepalese Rupees, upon receipt by us of your first demand in writing accompanied by a written statement stating that the Contractor is in breach of its obligation(s) under the Contract, without your needing to prove or to show grounds for your demand or the sum specified therein.

This guarantee shall expire, no later than the.....Day of ..... \*\*, and any demand for payment under it must be received by us at this office on or before that date.

.....  
**Seal of Bank and Signature(s)**

Note:  
All italicized text is for guidance on how to prepare this demand guarantee and shall be deleted from the final document.  
\* The Guarantor shall insert an amount representing the percentage of the Contract Price specified in the Contract in Nepalese Rupees.  
\*\* Insert the date thirty days after the date specified for the Defect Liability Period. The Employer should note that in the event of an extension of the time for completion of the Contract, the Employer would need to request an extension of this guarantee from the Guarantor. Such request must be in writing and must be made prior to the expiration date established in the guarantee. In preparing this guarantee, the Employer might consider adding the following text to the form, at the end of the penultimate paragraph: "The Guarantor agrees to a one-time extension of this guarantee for a period not to exceed [six months], in response to the Employer's written request for such extension, such request to be presented to the Guarantor before the expiry of the guarantee".

# Advance Payment Security

*Bank's Name, and Address of Issuing Branch or Office*

*(On Letter head of the Commercial bank or any Financial Institution eligible to issue Bank Guarantee as per prevailing Law)*

..... *Bank's Name, and Address of Issuing Branch or Office*.....

Beneficiary: .....*Name and address of employer*

Date : .....

Advance Payment Guarantee No.....

We have been informed that .....has entered into Contract No. .... ***Name and Address of Employer***.....***name of the Contractor***.....(hereinafter called "the Contractor")..reference number of the Contract.....dated ..... with you, for the execution of ...contract and brief description of Works ..... (hereinafter called "the Contract").

Furthermore, we understand that, according to the Conditions of the Contract, an advance payment in the sum..... name of the currency and amount in figures\*...(.... ***amount in words*** .....) is to be made against an advance payment guarantee.

At the request of the Contractor, we... ..... ***name of the Bank*** ..... hereby irrevocably undertake to pay you any sum or sums not exceeding in total an amount of.....name of the currency and amount in figures\*.....(***amount in words*** ... ..)upon receipt by us of your first demand in writing accompanied by a written statement stating that the Contractor is in breach of its obligation under the Contract because the Contractor used the advance payment for purposes other than the costs of mobilization in respect of the Works.

The maximum amount of this guarantee shall be progressively reduced by the amount of the advance payment repaid by the Contractor as indicated in copies of interim statements or payment certificates which shall be presented to us. This guarantee shall expire, at the latest, upon our receipt of a copy of the interim payment certificate indicating that eighty (80) percent of the Contract Price has been certified for payment, or on the ..... day of .....\*\*, whichever is earlier. Consequently, any demand for payment under this guarantee must be received by us at this office on or before that date.

.....  
**Seal of Bank and Signature(s)**

## **Note:**

All italicized text is for guidance on how to prepare this demand guarantee and shall be deleted from the final document.

\*The Guarantor shall insert an amount representing the amount of the advance payment in Nepalese Rupees of the advance payment as specified in the Contract.

\*\* Insert the date Thirty days after the expected completion date. The Employer should note that in the event of an extension of the time for completion of the Contract, the Employer would need to request an extension of this guarantee from the Guarantor. Such request must be in writing and must be made prior to the expiration date established in the guarantee. In preparing this guarantee, the Employer might consider adding the following text to the form, at the end of the penultimate paragraph: "The Guarantor agrees to a one-time extension of this guarantee for a period not to exceed [six months], in response to the Employer's written request for such extension, such request to be presented to the Guarantor before the expiry of the guarantee".